

# **PART 2 — BEST MANAGEMENT PRACTICES**

---



This page intentionally left blank.

# PART 2 — BEST MANAGEMENT PRACTICES

## TABLE OF CONTENTS



---

<b>Introduction</b> .....	2.5
Processes And Principles Of Erosion And Sedimentation .....	2.5
Activity and BMP Planning/Selection Sample Checklist #1 .....	2.7
Activity and BMP Pre-Construction/Maintenance Sample Checklist #2 .....	2.8
Activity and BMP Implementation Sample Checklist #3 .....	2.9
Activity and BMP Routine Part 1 BMPs Sample Checklist #4 .....	2.10
<b>The Eight Outcome Categories</b>	
Keep Water From Work Area .....	2.11
Reduce Potential for Soil From Becoming Water Borne – Or Air Borne .....	2.12
Filter/Perimeter Protection .....	2.13
Settling .....	2.14
Reduce Water Velocity/Erosive Forces .....	2.15
Containment .....	2.16
Habitat Protection/Maintenance .....	2.17
Reduce Potential for Contaminants Falling Into Water .....	2.18
<b>BMP/Outcome Categories Matrix</b> .....	2.19
<b>BMPs</b>	
Aqua Barrier .....	2.21
Back of Slope Planting .....	2.24
Cofferdam .....	2.26
Coir Fabric .....	2.29
Coir Log .....	2.31
Concrete Containment (1) .....	2.34
Concrete Containment (2) .....	2.37
Construction Access Road .....	2.39
Continuous Berm .....	2.42
Curb Inlet Sediment Trap .....	2.45
Dewatering .....	2.50
Diaper Netting .....	2.52
Ditch Lining .....	2.54
Diversion Berm .....	2.56
Diversion Channel .....	2.58
Dust Control .....	2.61
Excelsior Filled Log .....	2.63
Filter Fabric .....	2.65
Grass Lined Channel .....	2.67

---



TABLE OF CONTENTS (continued)

---

**BMPs Continued**

Gravel Filled Sump .....	2.71
Half Round Filter .....	2.72
Hand Seeding .....	2.75
Hydroseeding .....	2.77
Inlet Protection .....	2.79
Kimble Filter Pipe .....	2.86
Large Woody Material .....	2.88
Live Staking .....	2.93
Mulching .....	2.97
Plastic Covering .....	2.99
Plywood Work Platform .....	2.101
Rip Rap .....	2.103
Rock Check Dam .....	2.105
Sandbag .....	2.109
Sedimentation Sump .....	2.113
Silt Fence .....	2.114
Silt Mat .....	2.117
Siltation Pond/Settling Tank .....	2.119
Soil Stabilization (Blankets And Matting) .....	2.122
Straw Bale Barrier (1) .....	2.127
Straw Bale Barrier (2) .....	2.130
Straw Bale Barrier (3) .....	2.135
Straw Log .....	2.138
Stream Bank Stabilization (Bio-engineering) .....	2.141
Stream Bypass .....	2.142
Streambed Gravel .....	2.146
Surface Roughening .....	2.148
Sweeping .....	2.152
Temporary Sediment Trap .....	2.155
Triangular Silt Dike .....	2.158
Turbidity Curtain .....	2.162
Vactoring .....	2.166
Vegetative Buffer .....	2.168
Washed Rock .....	2.170

---

# PROCESSES AND PRINCIPLES OF EROSION AND SEDIMENTATION



**S**oil disturbance, whether by natural forces or by construction and maintenance activities, can accelerate the rate of erosion. Careful planning combined with proper selection and installation of erosion control measures can reduce the impact of construction and maintenance related erosion.

## SOIL EROSION PROCESS

- Splash erosion results when raindrops fall on bare or sparsely vegetated soil and detach the soil particles.
- Sheet erosion occurs when these soil particles are transported in a thin layer, or sheet, by flowing water.
- Rills and gullies are formed by concentrated, high velocity sheet flow. More soil detaches, increasing the erosion damage.
- Stream and channel erosion occurs by even higher rates of velocity and steepness of slope.
- Wind erosion occurs during dry weather conditions and high winds. Size of particles being moved is related to wind velocity. Particles moved by wind may cause air pollution, soil loss and/or water quality degradation.

Water quality and fish habitat are the major concerns associated with soil movement. BMPs combined with training and oversight will enable road maintenance personnel to lessen the effects of soil erosion from the work site.

## PRINCIPLES OF EROSION AND SEDIMENTATION CONTROL

Effective erosion and sedimentation control requires first that the soil surface be protected from the erosive forces of wind, rain, and runoff, and second that eroded soil is controlled onsite. The following principles shall be integrated into a system of control measures and management techniques to control erosion and reduce offsite sediment migration.

### **Minimize the Extent and Duration of Exposure**

Scheduling can be a very effective means of reducing the hazards of erosion. Schedule construction activities to minimize the exposed area and the duration of exposure. Maintenance activities can not always be scheduled, it is important to stabilize disturbed areas as quickly as possible in scheduled or unscheduled maintenance.



---

### **Protect Areas to be Disturbed from Stormwater Runoff**

Use berms, diversions, pumps, dams, barriers, sediment traps and constructed waterways to intercept runoff and divert it away from cut-and-fill slopes or other disturbed areas. Install these measures before beginning maintenance and/or land disturbing activities.

### **Stabilize Disturbed Areas**

Removing the vegetative cover and altering the soil structure by clearing the surface may increase an area's susceptibility to erosion. Apply stabilizing measures after the land is disturbed and implement temporary or permanent vegetation, mulches, or other BMP's to correspond with maintenance activities. During the winter season, October through June, no soils shall remain exposed and unworked for more than 2 days. During the summer season, July through September, no soils shall remain exposed and unworked for more than 7 days. This condition applies to all soils on site, whether at final grade or not.

### **Minimize Runoff Velocities**

Clearing existing vegetation may reduce the surface roughness and infiltration rate, thereby increasing runoff velocities and volumes. Use measures that break the slopes to reduce the problems associated with concentrated flow volumes and runoff velocities.

### **Retain Sediment on the Site**

Even with careful planning, some erosion is unavoidable. The resulting sediment can be reduced by BMP placement that reduce on site erosion. Plan the location where sediment deposition will occur and maintain access for maintenance cleanout. Plan, install and use sediment trap and basin BMPs before other land-disturbing activities (except in emergencies).

### **Inspect and Maintain BMPs**

Inspection and maintenance of BMPs is vital to the performance of erosion and sedimentation BMPs. It is essential to inspect all BMPs to determine that they are working properly and to ensure that problems are corrected as they are detected.

**ACTIVITY AND BMP**  
**Planning and Selection**  
**Sample Checklist #1**

Figure 14

ACTIVITY INFORMATION		
Location:	Maintenance Activity:	
Lead:	Date:	
Description of Activity:		
CHECKLIST		
Steps	Completed	Comments
1. Make site visit before starting work.		
2. Define activity, scope and limits.		
3. Identify sensitive areas and drainage features.		
4. Is environmental staff required to review plans or provide crew support?		
5. Are fish present (or likely to be present) in work area or activity impact area. (If yes, contact environmental support staff or WSDFW.)		
6. Will fish exclusion be required? (If yes, coordinate with designated staff or agency.)		
7. Review Maintenance Category BMP options related to site-specific conditions.		
8. Select applicable BMPs from Part 1 and 2 of the <i>Guidelines</i> .		
9. Secure permits.		
10. Read and understand all permit conditions. Resolve permit conditions before moving forward.		
11. Prepare construction/maintenance schedule, and/or sequence (Including installing, monitoring, maintaining, and removing BMP(s).)		
12. Schedule a pre-maintenance or pre-construction meeting as necessary.		
13. Review activity as possible model for training and/or adaptive management discussions.		

## ACTIVITY AND BMP

### Pre-construction and Pre-maintenance Meeting Sample Checklist #2

Figure 15

ACTIVITY INFORMATION		
Location:	Maintenance Activity:	
Lead:	Date:	
Description of Activity:		
CHECKLIST		
Steps	Completed	Comments
1. Invite appropriate personnel and/or agencies.		
2. Prepare agenda and attendance/sign-in form.		
3. Outline construction/maintenance, schedule, and/or sequence (Including installation, monitoring, maintaining, & removing BMP(s)).		
4. Identify sensitive areas and drainage features.		
5. If fish exclusion required, follow Fish Exclusion Protocol in Appendix E.		
6. Clarify roles & responsibilities of all personnel & agencies related to all aspects of the activity.		
7. Discuss permits, approvals and their conditions.		
8. If environmental staff is required to be onsite during work activities: introduce personnel and their role(s).		



**ACTIVITY AND BMP  
Installation, Monitoring, Maintianing  
and Removal Sample Checklist #3**

Figure 16

ACTIVITY INFORMATION		
Location:	Maintenance Activity:	
Lead:	Date:	
Description of Activity:		
CHECKLIST		
Steps	Completed	Comments
1. Identify/mark work area and location of BMP(s).		
2. Arrange for delivery of BMP(s) products.		
3. Environmental staff support as appropriate.		
4. Make sure BMP(s) are installed in accordance with the <i>Guidelines</i> , permit conditions and/or specifications.		
5. Monitor/check BMP(s) routinely to make sure BMP outcomes are achieved, and make repairs, adjustments, and/or additions as necessary.		
6. Remove BMP(s) and re-vegetate in accordance with the <i>Guidelines</i> .		



## ACTIVITY AND BMP

### Routine Part 1

### Sample Checklist #4

Figure 17

Task	Yes	No
1. Make site visit before starting work		
2. Define activity, scope, and limits		
3. Review Part 1 BMPs		
• Permit needed		
• Scheduling considerations		
• Equipment maintenance		
• Disturbed soil		
• Waste material removed		
• Spill kit		
• Part 2 BMPs needed		
• Evaluate using detailed checklist 1, 2, and/or 3		
4. Is environmental staff required? NO – continue maintenance YES – contact environmental staff for review		
5. In water work		
• Stop work		
• Contact environmental staff for review		
• Evaluate using detailed checklist 1, 2, and/or 3		

## OUTCOME CATEGORY: KEEP WATER FROM WORK AREA



---

**Definition:** The BMPs in this category are used to keep water from reaching the work area or disturbed soils generally by means of a bypass, diversion or interception process.

**Desired Outcome:** The desired outcome of these BMPs is to bypass or divert sheet flow, stormwater or stream flow around or through the work area. The intercepted water will be discharged to an acceptable storm drainage system or outfall.

**Applications:** These BMPs work well:

- In streams or ditches where the normal flow can be piped around the work area by temporarily damming and conveying the flow by pumping or gravity. (HPA)
- Covering stock piles or disturbed soils with impermeable fabric to intercept rainfall. Sheet flows shall be collected and diverted at the bottom of the covering.
- Diverting sheet flow around work area or disturbed soils by constructing upslope berms or channels.

**Limitations:** These BMPs are often used in combination with other BMPs (i.e., dewatering work area, grass-lined swales). Refer to *individual* (Part 2) BMP limitations.

**Permit Conditions:** Follow acceptable procedures, if required in HPA, to exclude fish from work area. Reintroduce water flow into the work area to reduce sediment transport. Comply with permit requirements. Inspect and maintain BMPs according to these Guidelines.

**BMP Options (include but not limited to):**

- Aqua Barrier.
- Cofferd Dam.
- Dewatering.
- Diversion Berm.
- Diversion Channel.
- Plastic Covering.
- Sandbag.
- Stream Bypass.
- Vactoring.



## **OUTCOME CATEGORY: REDUCE POTENTIAL FOR SOIL FROM BECOMING WATER BORNE– OR AIR BORNE**

---

**Definition:** The BMPs in this category work to keep soil particles in disturbed areas from becoming water borne or air borne.

**Desired Outcome:** The desired outcome of these BMPs is to reduce erosion by reducing soil particles from becoming water borne or air borne.

**Application:** These BMPs work well to stabilize:

- Slopes.
- Soils.
- Roadways.
- Channels.

**Limitations:** Often used in combination with other BMPs allowing the disturbed area to stabilize. Refer to individual BMP (Part 2) limitations.

**Permit Conditions:** Comply with permit requirements. Inspect and maintain BMPs according to these guidelines.

**BMP Options (include but not limited to):**

- Back of Slope Planting.
  - Construction Access Road.
  - Ditch Lining.
  - Dust Control.
  - Filter Fabric.
  - Grass Lined Channel.
  - Hand Seeding.
  - Hydroseeding.
  - Live Staking.
  - Mulching.
  - Plastic Covering.
  - Soil Stabilization (Blankets/Matting).
  - Surface Roughening.
  - Sweeping.
  - Vegetative Buffer.
-

## **OUTCOME CATEGORY: FILTER/PERIMETER PROTECTION**



---

**Definition:** The BMPs in this category reduce erosion and sedimentation of soil particles/contaminants as the water passes through a filtering device. This outcome will also apply to perimeter protection around the job site.

**Desired Outcome:** The desired outcome of these BMPs is to reduce soil particles/contaminants before the water discharges from the job site.

**Application:** These BMPs work well:

- When the rate of flow is relatively low and the filter can be inspected and maintained to ensure the BMP continues to function.
- Perimeter protection around job site.

**Limitations:** Not effective in areas of high flows. Refer to individual BMP (Part 2) limitations.

**Permit Conditions:** Comply with permit requirements. Inspect and maintain BMPs according to these guidelines.

### **BMP Options (include but not limited to):**

- Coir Log.
- Continuous Berm.
- Curb Inlet Sediment Trap.
- Excelsior Filled Log.
- Filter Fabric.
- Grass Lined Channel.
- Gravel Filled Sump.
- Half Round Filter.
- Inlet Protection.
- Kimble Filter Pipe.
- Silt Fence.
- Silt Mat.
- Straw Bale Barrier (1).
- Straw Bale Barrier (2).
- Straw Bale Barrier (3).
- Straw Log.
- Washed Rock.



## **OUTCOME CATEGORY: SETTLING**

---

**Definition:** The BMPs in this category allow particles/contaminants to settle as the water velocity decreases.

**Desired Outcome:** The desired outcome of these BMPs is to allow sediment to settle out of the water. This will reduce soil particles/contaminants from leaving the job site.

**Application:** These BMPs work well:

- When the rate of flow is relatively low.
- When there is sufficient space or volume to properly size a settling BMP.

**Limitations:** Not effective in areas of high flows. Refer to individual BMP (Part 2) limitations.

**Permit Conditions:** Comply with permit requirements. Inspect and maintain BMPs according to these guidelines.

**BMP Options (include but not limited to):**

- Coir Log.
  - Continuous Berm.
  - Curb Inlet Sediment Trap.
  - Excelsior Filled Log.
  - Filter Fabric.
  - Rock Check Dam.
  - Sandbag.
  - Sedimentation Sump.
  - Silt Fence.
  - Silt Mat.
  - Siltation Pond/Tank.
  - Straw Bale Barrier (1).
  - Straw Bale Barrier (2).
  - Straw Bale Barrier (3).
  - Straw Log.
  - Temporary Sediment Trap.
  - Triangular Silt Dike.
  - Turbidity Curtain.
-

## **OUTCOME CATEGORY: REDUCE WATER VELOCITY/EROSIVE FORCES**



---

**Definition:** The BMPs in this category reduce or diminish the water velocity, thereby dissipating its erosive force.

**Desired Outcome:** The desired outcome of these BMPs is to create energy dissipation and reduce erosion.

**Application:** These BMPs work well:

- On stream and ditch banks.
- In swales/grass lined channels.
- In waterbodies.
- On slopes.
- On large disturbed areas.

**Limitations:** These BMPs should not be used when maintenance activities are conducted in locations that could reduce actual or potential high flow salmonid refuge functions. These BMPs may be used if required by permit conditions. Refer to individual BMP (Part 2) limitations.

**Permit Conditions:** Comply with permit requirements. Inspect and maintain BMPs according to these guidelines.

### **BMP Options (include but not limited to):**

- Back of Slope Planting.
- Coir Fabric.
- Coir Log.
- Continuous Berm.
- Ditch Lining.
- Excelsior Filled Log.
- Hand Seeding.
- Hydroseeding.
- Large Woody Material.
- Live Staking.
- Mulching.
- Rip Rap.
- Rock Check Dam.
- Sandbag.
- Silt Fence.
- Silt Mat.
- Straw Bale Barrier (1).
- Straw Bale Barrier (2).
- Straw Bale Barrier (3).
- Straw Log.
- Stream Bank Bio-Engineering.
- Surface Roughening.
- Triangular Silt Dike.
- Turbidity Curtain.
- Vegetative Buffer.



## **OUTCOME CATEGORY: CONTAINMENT**

---

**Definition:** The BMPs in this category retain water and soil particles/contaminants on the work site.

**Desired Outcome:** The desired outcome of these BMPs is to reduce water discharge from the job site.

**Application:** These BMPs work well:

- In enclosed drainage systems.
- In swales.
- In open drainage systems.
- In waterbodies. (bridge maintenance etc)

**Limitations:** These BMPs should not be used when maintenance activities are conducted in locations that could reduce actual or potential high flow salmonid refuge functions. These BMPs may be used if required by permit conditions. Refer to individual BMP (Part 2) limitations.

**Permit Conditions:** Comply with permit requirements. Inspect and maintain BMPs according to these guidelines.

**BMP Options (include but not limited to):**

- Concrete Containment (1).
- Concrete Containment (2).
- Vactoring.



## **OUTCOME CATEGORY: HABITAT PROTECTION/MAINTENANCE**



---

**Definition:** The BMPs in this category maintain or protect habitat.

**Desired Outcome:** The desired outcome of these BMPs is to maintain or protect habitat by providing:

- Bank/slope stabilization.
- Spawning/rearing areas.
- Habitat shading.
- Reducing erosion by providing ground cover, binding soil particles with roots, and lowering water velocity.
- Habitat for primary production.
- Habitat for prey base organisms such as macro-invertebrates.

**Application:** These BMPs work well in:

- Riparian areas.
- Sensitive areas.
- Watercourses and streams.

**Limitations:** These BMPs should be done in accordance with project design. Refer to individual BMP (Part 2) limitations.

**Permit Conditions:** Comply with permit requirements. Inspect and maintain BMPs according to these guidelines.

**BMP Options (include but not limited to):**

- Coir Fabric.
- Coir Log.
- Excelsior Filled Log.
- Hand Seeding.
- Hydroseeding.
- Large Woody Material.
- Live Staking.
- Streambed Gravel.



## **OUTCOME CATEGORY: REDUCE POTENTIAL FOR CONTAMINANTS FALLING INTO WATER**

---

**Definition:** The BMPs in this category reduce the potential for the contaminants from the work area from entering the water. This outcome can be achieved by capturing falling particles from bridge or other over-water work.

**Desired Outcome:** The desired outcome of these BMPs is to reduce contaminants from entering the water.

**Application:** These BMPs work well:

- On bridge or pipeline maintenance projects.

**Limitations:** Refer to individual BMP (Part 2) limitations.

**Permit Conditions:** When used in watercourses or streams, these BMPs must be used in accordance with permit requirements. Inspect and maintain BMPs according to these guidelines.

**BMP Options (include but not limited to):**























































- Diaper Netting.
- Plywood Work Platform.



## BMP Outcome Category Matrix

Figure 13

 = Recommended BMP Application but not limited to











































		BMP OUTCOME CATEGORY							
BMP	PAGE	Keep Water From Work Area	Reduce Potential for Soil Erosion	Filter / Perimeter Protection	Settling	Reduce Water Velocity / Erosive Forces	Containment	Habitat Protection / Maintenance	Reduce Potential for Contaminants Falling Into Water
AQUA BARRIER	2.20								
BACK OF SLOPE PLANTING	2.23								
COFFERDAM	2.25								
COIR FABRIC	2.28								
COIR LOG	2.30								
CONCRETE CONTAINMENT (1)	2.33								
CONCRETE CONTAINMENT (2)	2.36								
CONSTRUCTION ACCESS ROAD	2.38								
CONTINUOUS BERM	2.41								
CURB INLET SEDIMENT TRAP	2.44								
DEWATERING	2.49								
DIAPER NETTING	2.51								
DITCH LINING	2.53								
DIVERSION BERM	2.55								
DIVERSION CHANNEL	2.57								
DUST CONTROL	2.60								
EXCELSIOR FILLED LOG	2.62								
FILTER FABRIC	2.64								
GRASS LINED CHANNEL	2.66								
GRAVEL FILLED SUMP	2.70								
HALF ROUND FILTER	2.71								
HAND SEEDING	2.73								
HYDROSEEDING	2.75								
INLET PROTECTION	2.77								
KIMBLE FILTER PIPE	2.84								
LARGE WOODY MATERIAL	2.86								
LIVE STAKING	2.91								
MULCHING	2.95								
PLASTIC COVERING	2.97								
PLYWOOD WORK PLATFORM	2.99								



## BMP Outcome Category Matrix

Figure 13 Continued

 = Recommended BMP Application but not limited to

BMP	PAGE	BMP OUTCOME CATEGORY							
		Keep Water From Work Area	Reduce Potential for Soil from Becoming Water- or Airborne	Filter / Perimeter Protection	Settling	Reduce Water Velocity / Erosive Forces	Containment	Habitat Protection / Maintenance	Reduce Potential for Contaminants Falling Into Water
RIP RAP	2.101								
ROCK CHECK DAM	2.103								
SANDBAG	2.107								
SEDIMENTATION SUMP	2.111								
SILT FENCE	2.112								
SILT MAT	2.115								
SILTATION POND/SETTLING TANK	2.117								
SOIL STABILIZATION (Blankets/Matting)	2.120								
STRAW BALE BARRIER (1)	2.125								
STRAW BALE BARRIER (2)	2.128								
STRAW BALE BARRIER (3)	2.133								
STRAW LOG	2.136								
STREAM BANK STABILIZATION	2.139								
STREAM BYPASS	2.140								
STREAMBED GRAVEL	2.144								
SURFACE ROUGHENING	2.146								
SWEEPING	2.150								
TEMPORARY SEDIMENT TRAP	2.153								
TRIANGULAR SILT DIKE	2.156								
TURBIDITY CURTAIN	2.160								
VACTORING	2.164								
VEGETATIVE BUFFER	2.166								
WASHED ROCK	2.168								



---

## **DESCRIPTION**

An aqua barrier is a manufactured vinyl tube filled with water to provide a temporary/portable dam or barrier positioned to contain or divert the movement of water.

## **PURPOSE**

The purpose of this BMP includes, but is not limited to:

- Providing a dry construction area in a stream or waterway.
- Providing a bypass for a stream or waterway.
- Temporary reservoirs for water storage.
- Excluding waters from work area under and around bridges or piers.

## **APPLICATIONS**

This BMP may be used for stream diversion at a construction site. It may be used in fish habitat restoration, flood control, erosion control through diversion or containment of flowing water, silt containment, sedimentation collection or settling ponds, and/or as a portable dam.

## **LIMITATIONS**

This BMP should not be used:

- To cross more than 2/3 of the main flow of any salmonid bearing water at the time of the year when any life history stage of salmonids are expected to be present. (unless required by permit)
- Other than specified by the manufacturer's guidelines.

## **CONSTRUCTION GUIDELINES**

- When used in watercourses or streams, aqua barriers must be used in accordance with permit requirements.
- Refer to Appendix E for Fish Exclusion Protocols.
- Follow manufacturer recommendations and guidelines for installation and safety measures.
- Knives shall be worn by workers for emergency deflation.
- Keep a repair kit on site in case of small punctures.



*Aqua barrier used as  
coffer dam*

- Remove any visible rocks or sharp objects prior to installing barrier.
- The aqua barrier can be deployed on dry ground, in standing and/or flowing water.
- Multiple aqua barriers can be joined with connections.

### **BMP MAINTENANCE**

- Inspect BMPs several times daily during the workweek. Schedule additional inspections during storm events. Any required repairs shall be made.
- Repair punctures with repair kit immediately.
- Allow to dry before rolling up for storage.
- Store away from chemicals, and above 10° F.

### **BMP REMOVAL**

- Follow manufacturer recommendations for removal.
- Remove BMP (recycle and/or reuse if applicable).
- Water discharged from water barrier shall meet water quality temperature standards at the point of discharge.





*Installing aqua barrier in river to provide a dry construction area*





## **BMP**

### **BACK OF SLOPE PLANTING**

---

#### **DESCRIPTION**

Back of slope planting requires leaving the roadway slope clear for public safety. This BMP includes planting grass, forbs, small trees and brush. This BMP provides long term soil stabilization and/or reduces water velocity/erosive forces.

#### **PURPOSE**

The purpose of this BMP includes, but is not limited to:

- Ditch slopes vegetated with grass and forbs to reduce exposed soil.
- Planting trees and brush outside of the ditch on the back of the slope allowing plants to grow over the ditch or channel.
- Providing shade as long as it does not become a public safety hazard (No trees larger than 4-inches allowed in clear zone or recovery area).

#### **APPLICATIONS**

This BMP may be used in ditches (including ditches which are watercourses or streams) parallel to roadways or at road crossings. Revegetation plans will be done in accordance with permit requirements and federal highway safety design or standards. It may be used in combination with other BMPs.

This BMP provides long term soil stabilization once plantings have been established. Soil stabilization can only be achieved in combination with other BMPs. For example; Grasses and forbs on shoulder and in ditch slopes with brush, shrubs or trees behind the ditch.

#### **LIMITATIONS**

This BMP should not be used:

- If it creates a potential public safety hazard.
- In clear zone areas.
- If it could cause water flow problems that may result in flooding of the roadway..

#### **CONSTRUCTION GUIDELINES**

- Select appropriate native vegetation for the location.
-





- Review planting guidelines; plant at the appropriate time of year.
- Planting must be done in accordance with design and/or permit conditions.

### **BMP MAINTENANCE**

- Inspect during plant establishment period. Replant, due to plant mortality, as necessary.

### **BMP REMOVAL**

- BMP removal is not necessary.

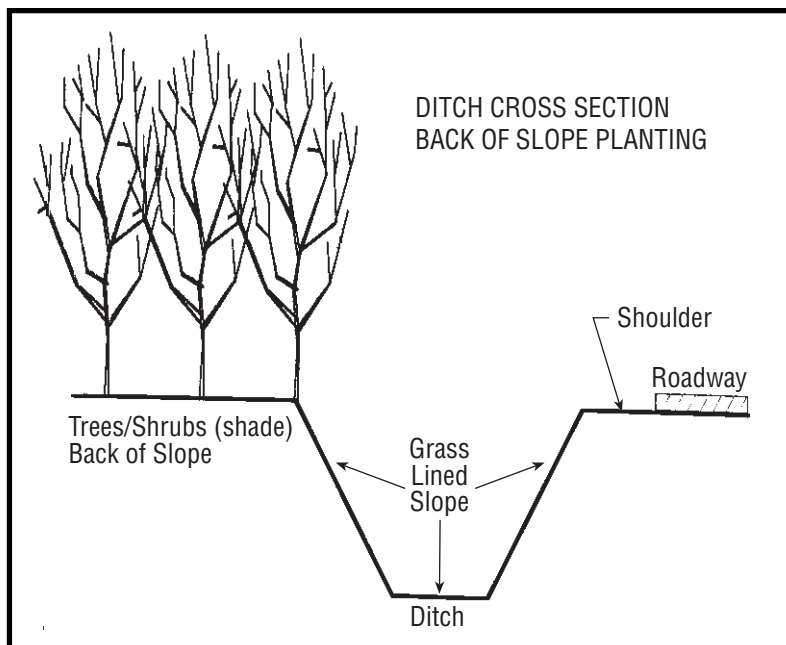



## **BMP COFFERDAM**

---

### **DESCRIPTION**

A cofferdam is a temporary structure built into a waterway to enclose a construction area and reduce sediment pollution from construction work in and under water. Cofferdams can be made of steel, rock, sand bags, wood or aqua barriers.

### **PURPOSE**

The purpose of this BMP includes, but is not limited to:

- Dewatering construction areas.

### **APPLICATIONS**

This BMP may be used in construction activities such as culvert installation, bridges, piers, or abutments. It may be used in combination with other barriers and is commonly used in conjunction with stream bypass and/or pumps.

### **LIMITATIONS**

This BMP should not be used:

- In deep water unless designed or reviewed by an engineer.

### **CONSTRUCTION GUIDELINES**

- When used in watercourses or streams, cofferdams must be used in accordance with permit requirements.
- Refer to Appendix B for Fish Exclusion Protocols.
- Construction guidelines depend on cofferdam material selection. See pictures for construction details.

### **BMP MAINTENANCE**

- During construction, inspect BMPs daily during the workweek. Schedule additional inspections during storm events. Make any required repairs.
- Repair gaps, holes or scour.



---

## **BMP REMOVAL**

- Evaluate site to determine BMP is no longer needed (the area has stabilized—potential of sediment laden water exiting the area has passed).
- Remove sediment buildup in front of BMP.
- Remove BMP (recycle and/or re-use if applicable).
- Re-vegetate area disturbed by BMP removal (if applicable).



*Sandbags used as a cofferdam*



## SANDBAG COFFER DAM DETAIL

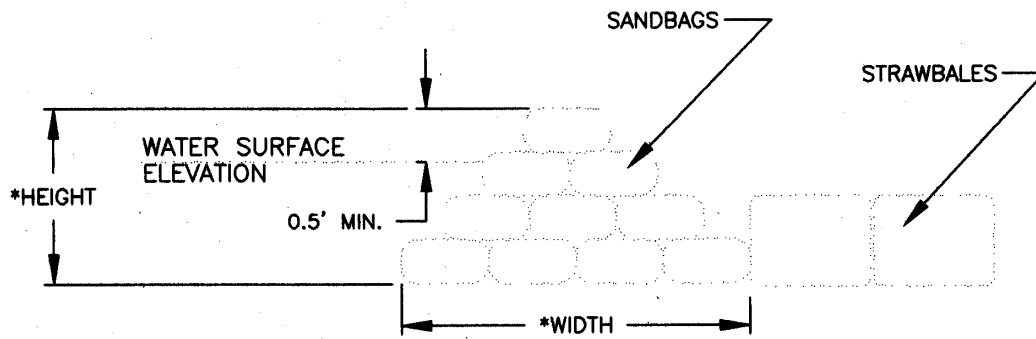

\* HEIGHT AND WIDTH OF COFFER DAM SHALL BE DETERMINED BY THE WATER SURFACE ELEVATION AT THE TIME OF CONSTRUCTION.

### NOTES:

1. SANDBAGS SHALL BE USED IN ACCORDANCE WITH APPLICABLE PERMITS.
2. INSTALL COFFER DAM AND DEWATER SITE PRIOR TO CONSTRUCTION
3. PROVIDE ADEQUATE FREEBOARD.

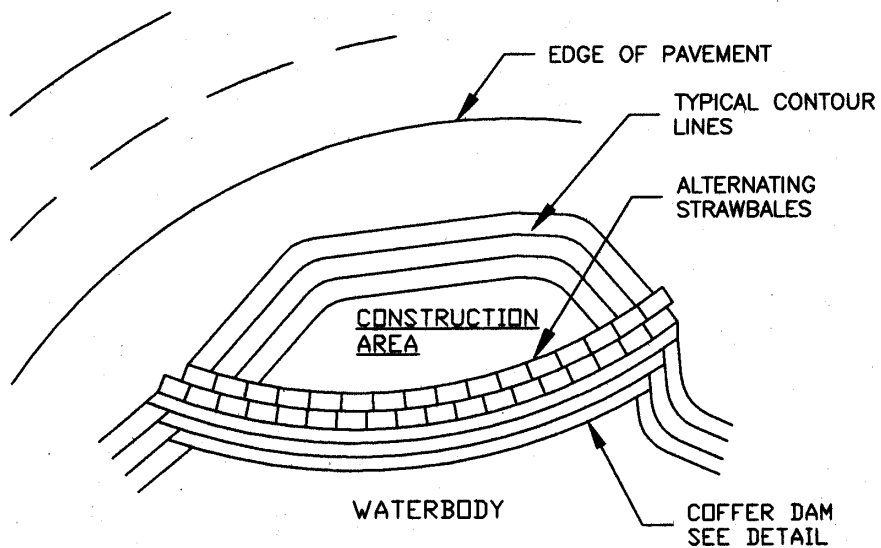



---

## **DESCRIPTION**

Coir Fabric is a geo-textile product made from coconut fibers loosely woven into a fabric usually packaged in roll form. This fabric can be used to provide a reduction in water velocity/erosive forces and/or habitat protection/maintenance.

## **PURPOSE**

The purpose of this BMP includes, but is not limited to:

- Decreasing bank erosion in high flow/high velocity channels.
- Long term slope stabilization.
- Stream and riverbank stabilization.
- Revegetation projects.

## **APPLICATIONS**

This BMP may be used to provide stabilization/protection to the soil surface of steep slopes, stream and/or river banks. It can be used in combination with vegetation to reinforce soil in high flow/high velocity waters and on slopes as steep as 1 horizontal to 1 vertical. It may be used as bank stabilization before vegetation/re-vegetation has occurred.

## **LIMITATIONS**

This BMP should not be used:

- In the streambed of a channel.
- When short term biodegradability is required.

## **CONSTRUCTION GUIDELINES**

- When used in water courses or streams, this BMP must be used in accordance with permit requirements.
- The fabric may be laid out horizontally or vertically on a slope.
- Use stakes or staples to anchor fabric to ground. Use anchoring devices on the edges and in the field of the fabric.
- Lay loosely on the surface so fabric makes contact with the ground. (Don't stretch the fabric.)



- If the seam is perpendicular with water flow, overlap fabric at least 18-inches in the direction of water flow.
- If the seam is parallel with the water flow, overlap edges at least 8-inches, staking both edges securely.
- The fabric should be trenched at least 12" deep at top and bottom ends of the installation to prevent undercutting of the fabric.
- Hand Seeding and/or Hydroseeding should occur prior to coir fabric placement.
- Live staking may be done after coir fabric placement by piercing fabric.

### **BMP MAINTENANCE**

- During construction, inspect BMPs daily during the work week. Schedule additional inspections during storm events. Make any required repairs.

### **BMP REMOVAL**

- BMP removal is not necessary.



*Coir fabric*



---

## **DESCRIPTION**

A coir log is a manufactured coconut fiber log used as a structural and rooting mechanism for bioengineered systems. These logs can be used to provide filter/perimeter protection, settling, reduction in water velocity/erosive forces and habitat protection/maintenance. They may be cut or folded, to the appropriate length, to fit the desired location.

## **PURPOSE**

The purpose of this BMP includes, but is not limited to:

- Intercepting sheet flow.
- Intercepting and detaining small amounts of water from disturbed areas during construction operations in order to promote settling of soil particles.
- Filtering soil particles and debris.
- Trapping topsoil and retaining moisture from rainfall, which aids in growth of seedlings planted along the upslope side of the rolls.

## **APPLICATIONS**

This BMP may be used for temporary check dams in ditches of any dimension, temporary soil stockpile protection, drop inlet protection, temporary interceptor dike and swale, check dam in ditches and/or bank stabilization. Coir logs may also be used for habitat protection at the toe of a bank and can be incorporated with vegetative planting. This BMP may be used for perimeter sediment control. This BMP is particularly useful in areas where the effects of soil disturbance need to be minimized. It may be used in combination with other BMPs.

## **LIMITATIONS**

This BMP should not be used:

- Where flow volume or velocity inhibit BMP function.
- When maintenance activities conducted in locations could reduce actual or potential high flow salmonid refuge functions, this BMP will be used if required by permit conditions.



### **CONSTRUCTION GUIDELINES**

- Coir log installation must be done in accordance with applicable design and/or permit conditions.
- Install to prevent water from going around or under BMP.
- BMP must be staked (wood only) to insure soil particle containment.
- When using as a check dam, prior to installation, cut or fold to proper length.

### **BMP MAINTENANCE**

- During construction, inspect BMPs daily during the workweek. Schedule additional inspections during storm events. Make any required repairs.
- Sediment should be removed when deposits reach one-half the height of the BMP.

### **BMP REMOVAL**

- Evaluate site to determine BMP is no longer needed (the area has stabilized—potential of sediment laden water exiting the area has passed).
- Remove sediment buildup in front of BMP.
- Removal of BMP may not always be necessary.
- Depending upon BMP placement, re-vegetation of site may be necessary.





*Coir logs used as habitat protection at the toe of a bank*



*Coir log used to allow settling and to decrease water velocity/erosive forces*



## **BMP CONCRETE CONTAINMENT (1)**

---

### **DESCRIPTION**

**C**oncrete containment is the method(s) of containing uncured concrete that is pumped or poured into forms while repairing structures in or around watercourses.

### **PURPOSE**

The purpose of this BMP includes, but is not limited to:

- Reducing uncured concrete and chemicals from leaving the work site and entering the adjacent body of water.

### **APPLICATIONS**

This BMP may be used when dewatering is not possible for bridge repair work. Concrete containment devices may include fiberglass/steel column forms, a "Sea-form" bag system and/or steel plates to line work area. It may be used in combination with other BMPs such as cofferdams, turbidity curtains and/or dewatering/silt ponds.

### **LIMITATIONS**

- Limitations are site specific.

### **CONSTRUCTION GUIDELINES**

- When used in watercourses or streams, this BMP must be used in accordance with permit requirements.
- Concrete containment systems should be designed or reviewed by an engineer.
- Identify work site.
- Isolate work area. If possible, dewater construction area.
- As conditions allow, provide approved secondary containment.
- Have adequate fuel supply and backup pumps in the event of emergency or mechanical failure.
- For tool and/or equipment cleanup onsite, a temporary sump may be used to contain water from cleanup.
- Remove material from sump after cleanup is complete.



### **BMP MAINTENANCE**

- Inspect structure during construction for leaks.
- Repair any leaks in structure.
- Contain and remove any excess materials, such as chemicals and/or concrete.

### **BMP REMOVAL**

- Remove BMP as concrete and permit conditions require; this may be immediately or it may be up to 10 days after the concrete is cured (recycle and/or re-use if applicable).

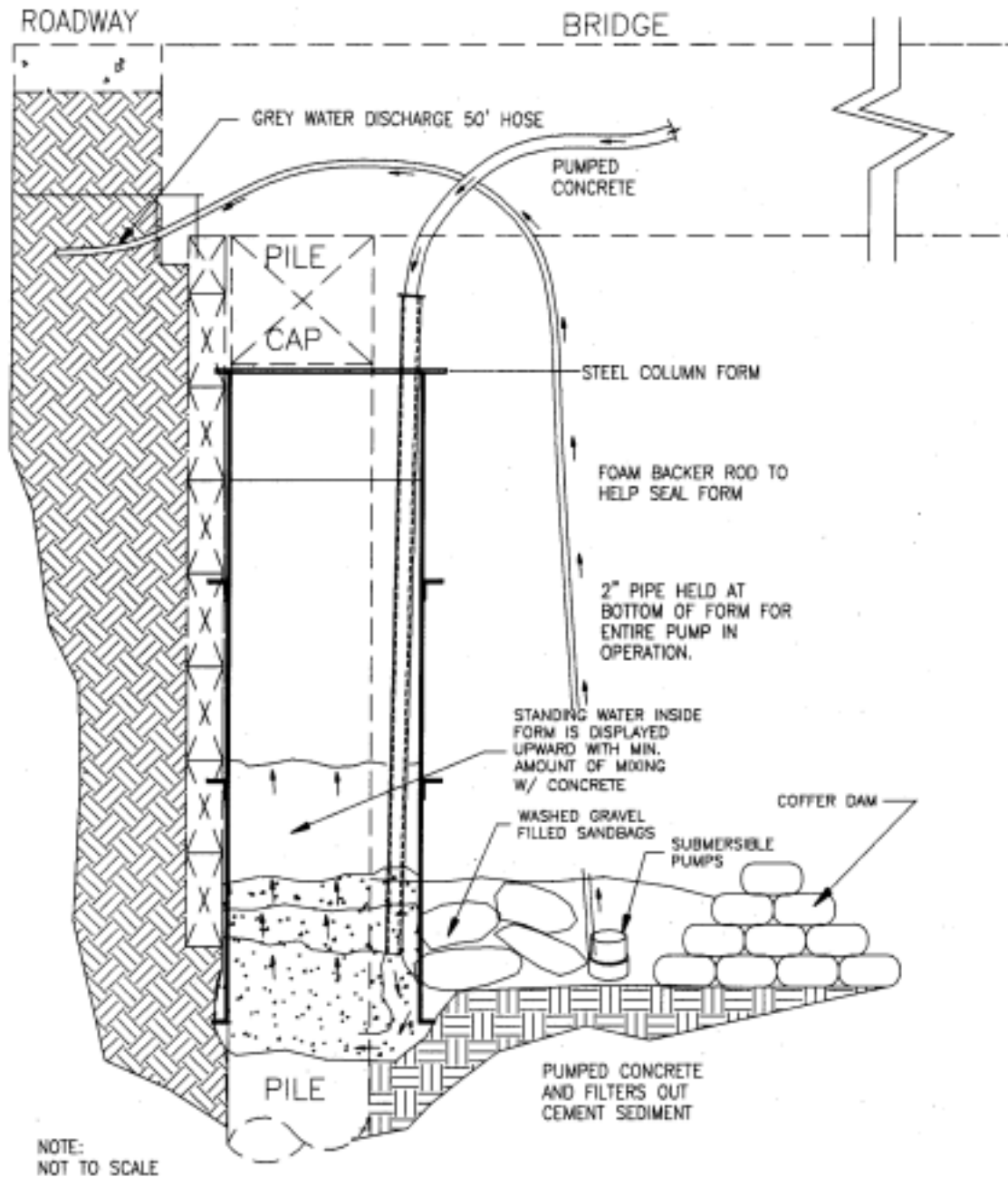

FIGURE : CONCRETE CONTAINMENT FOR BRIDGE ABUTMENT SCOUR REPAIR WORK

# BMP

## CONCRETE CONTAINMENT (2)



---

### DESCRIPTION

Concrete containment is a method of containing uncured concrete pumped or poured into forms while constructing and/or repairing structures, such as sidewalks, curbs, gutters, manholes and catch basins.

### PURPOSE

The purpose of this BMP includes, but is not limited to:

- Containing uncured concrete and chemicals from leaving the work site.
- Containing water from exposed aggregate work areas.
- Containing water from equipment cleanup.

### APPLICATIONS

This BMP may be used when performing flatwork, curb and gutter or utility concrete repair work. It may be used in combination with other BMPs.

### LIMITATIONS

- Limitations are site specific.

### CONSTRUCTION GUIDELINES

- When used in watercourses or streams, this BMP must be used in accordance with permit requirements.
- Locate work area.
- Isolate work area.
- Install drain protection downslope, for example, filter fabric, drainage plug and/or use a Vactor truck.
- Cover catch basins adjacent to work area with filter fabric.
- For tool and/or equipment cleanup onsite, a temporary sump may be used to contain water from cleanup.
- Remove material from sump after cleanup is complete.



### **BMP MAINTENANCE**

- Contain and remove any excess materials, such as chemicals and/or concrete.
- Make sure onsite cleanup sump is of adequate size and overflow does not occur.
- Remove sediment buildup as required.

### **BMP REMOVAL**

- Remove waste material.
- Re-vegetate and/or restore area disturbed by BMP.

# BMP

## CONSTRUCTION ACCESS ROAD



---

### DESCRIPTION

A construction access road is a stabilized rock (or an alternative material) pad located at points of vehicular ingress and egress at a construction site. The construction access road may include a fabric underliner.

### PURPOSE

The purpose of this BMP includes, but is not limited to:

- Allowing stability for vehicle access to construction sites.
- Limiting mud and debris deposited on roadways from adjacent construction sites.

### APPLICATIONS

This BMP may be used at construction sites with unstable soils and/or steep slopes to gain traction, especially during wet weather. It may be used in combination with other BMPs.

### LIMITATIONS

This BMP should not be used:

- As the sole BMP.

### CONSTRUCTION GUIDELINES

- Unsuitable material should be excavated prior to placement of fabric and rock.
- Place an optional "fabric underliner" the full width and length of the access road, as required by design.
- Compact road as appropriate.
- Drainage is designed to state and local design standards (see sediment ponds).

### BMP MAINTENANCE

- During construction, inspect BMPs daily during the workweek. Schedule additional inspections during storm events. Make any required repairs.
- Materials spilled, dropped or tracked from vehicles onto roadways should be removed.





## BMP: CONSTRUCTION ACCESS ROAD (continued)

---

- Water trucks will not be used to remove dropped, spilled, or tracked materials, unless the water can be treated by other BMPs.

### **BMP REMOVAL**

- Remove BMP if appropriate (recycle and/or re-use if applicable).
- Re-vegetate and/or restore area disturbed by BMP.



*Access road installation*





BMP: CONSTRUCTION ACCESS ROAD (continued)

ACCESS ROAD

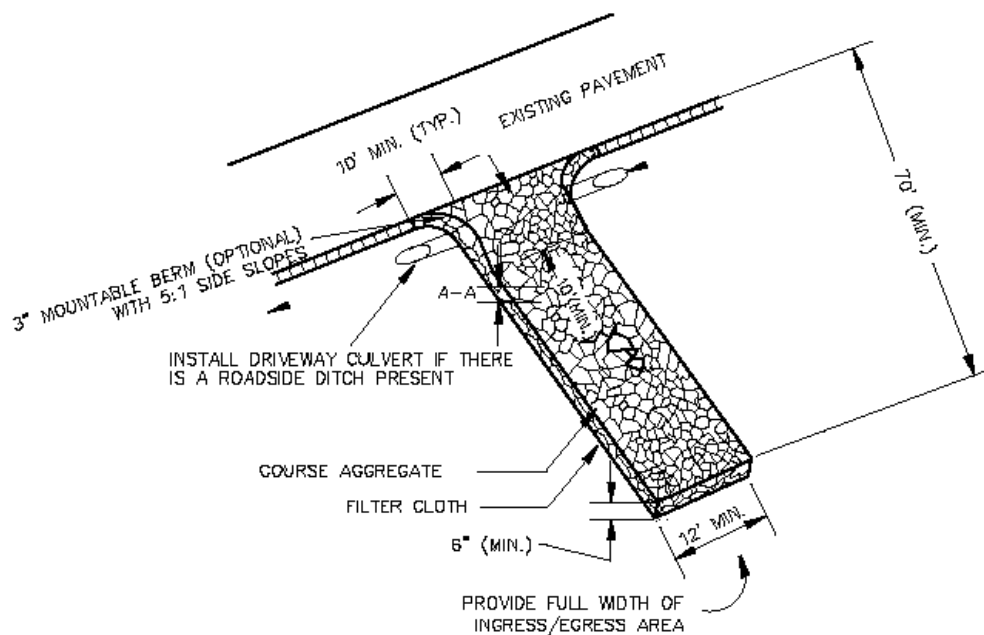

SECTION A-A

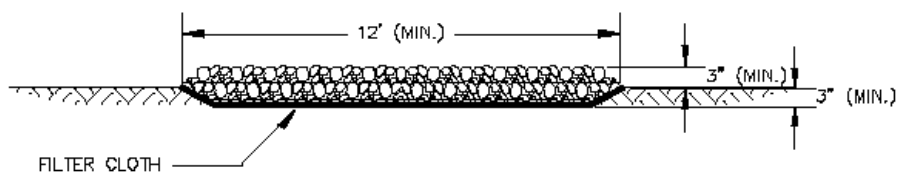

*Construction access road detail*



## **BMP CONTINUOUS BERM**

---

### **DESCRIPTION**

A continuous berm is a temporary diversion dike or sediment barrier constructed with infill material, either soil, sand or gravel, encased within geosynthetic fabric. This BMP requires a Continuous Berm Machine (CBM) for filling and placing. A continuous berm can be used to provide filter/perimeter protection, settling, and reduction in water velocity/erosive forces.

### **PURPOSE**

The purpose of this BMP includes, but is not limited to:

- Diverting sheet flow.
- Intercepting sheet flow.
- Intercepting and detaining small amounts of water from disturbed areas during construction operations in order to allow settling of soil particles.
- Decreasing down slope sheet flow velocity.
- Retaining soil particles/debris on site.

### **APPLICATIONS**

This BMP may be used for perimeter sediment control. It may be used in combination with other BMPs.

This BMP may be used below disturbed areas subject to sheet and rill erosion where drainage area is no greater than .25 acre per 100 lineal feet of barrier and the slope behind the barrier should be no steeper than 2 horizontal feet to 1 vertical foot. On relatively flat slopes the maximum disturbed slope distance should not exceed 100 feet. The allowable disturbed slope distance decreases as the slope gets steeper.

### **LIMITATIONS**

This BMP should not be used:

- Directly in water courses.
- In front of storm outlets.



---

## **CONSTRUCTION GUIDELINES**

- Use a Continuous Berm Machine (follow operating manual).
- Apply to relatively smooth surfaces to form a tight seal with ground.
- A source of infill material is required (sand, gravel, or local soils).
- Increase the elevation at the ends of the BMP installation to prevent "end runs."

## **BMP MAINTENANCE**

- During construction, inspect BMPs daily during the workweek. Schedule additional inspections during storm events. Make any required repairs.
- Repair any damaged BMPs due to end runs or undercutting.
- Sediment should be removed when deposits reach one-half the height of the BMP.

## **BMP REMOVAL**

- Evaluate site to determine BMP is no longer needed (the area has stabilized—potential of sediment laden water exiting the area has passed).
- Remove sediment buildup in front of BMP.
- Remove BMP (recycle and/or re-use is applicable).
  - Removal consists of slitting and removing the fabric.
  - Remove the infill material from the site or grade infill material into the existing shoulder or soil.
- Depending upon BMP placement, re-vegetation of site may be necessary.



BMP: CONTINUOUS BERM (continued)



*Continuous berm*



*Continuous berm machine*



*Continuous berm retaining soil particles and debris*



*Continuous berm intercepting water from construction area*

# BMP

## CURB INLET SEDIMENT TRAP



---

### DESCRIPTION

A curb inlet sediment trap is a temporary barrier constructed from concrete blocks, gravel, filter fabric or gravel bag filter. Geotextile grade covers and geotextile collectors (inserts) are available pre-manufactured. Curb inlet sediment traps can be used to provide filtering and settling of soil particles.

### PURPOSE

The purpose of this BMP includes, but is not limited to:

- Reducing the soil particles discharged into storm drains by settling and/or filtering the runoff.
- Allowing for overflow from high runoff events.
- Allowing the ponded water to filter rapidly through gravel.

### APPLICATIONS

These BMPs are used at curb inlets on gently sloping streets where water can pond and allow particles to filter or settle.

### LIMITATIONS

This BMP should not be used:

- Where the ponding area will encroach into the travel lanes or pedestrian walkways.
- Steep grades.

### CONSTRUCTION GUIDELINES

- A spillway structure shall be constructed with the sandbags to allow overflow.
- Place sandbags in a curved row from the top of curb at least 3 feet into the street; curve the ends upward.
- Overlap several layers of bags and pack tightly.
- Leave a one-sandbag gap at the upstream end in the top row to act as a spillway.
- Slope runoff should flow over blocks and gravel and not be bypassed over the curb.



- Install pre-manufactured grade covers and geo-textile collectors in accordance with manufacturer specifications.
- Install grade covers, geo-textile collectors, or filter fabric on top of or in front of the inlet. Construct a small dam immediately downstream of the inlet to stop flow.

### **BMP MAINTENANCE**

- Sediment shall be removed.
- If the gravel becomes clogged with sediment, it must be carefully removed from the inlet and either cleaned or replaced.
- During construction, inspect BMPs daily during the workweek. Schedule additional inspections during storm events. Make any required repairs.

### **BMP REMOVAL**

- Evaluate site to determine BMP is no longer needed (the area has stabilized—potential of sediment laden water exiting the area has passed).
- Remove sediment buildup in front of BMP.
- Remove BMP (recycle and/or re-use if applicable).
- Use vacuum sweeper or hand broom to clean road surface.
- Use "Vactor-Truck" to clean drainage system.



*A silt sock installed in a catch basin to trap/filter waterborne soil particles*

---

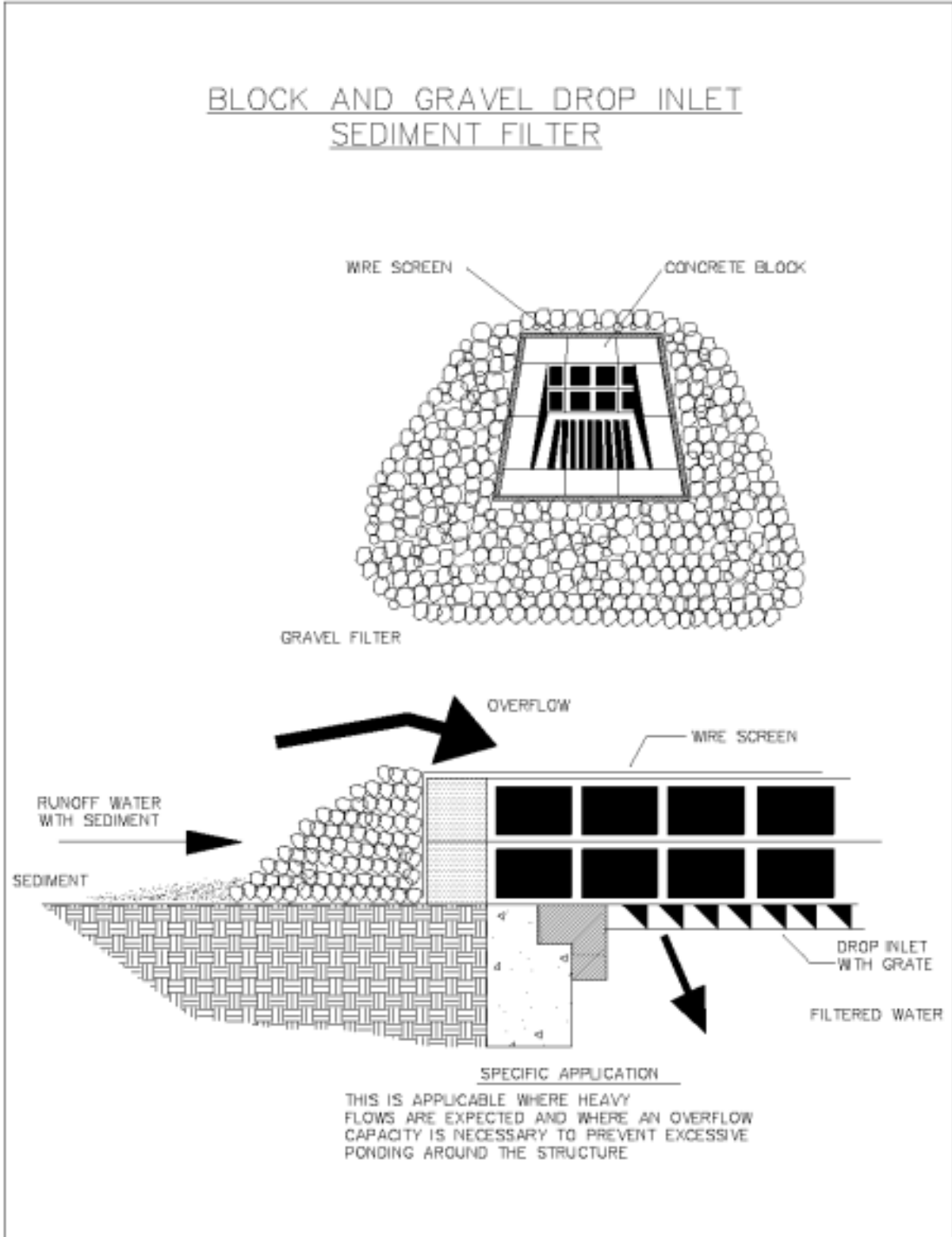





BMP: CURB INLET SEDIMENT TRAP (continued)

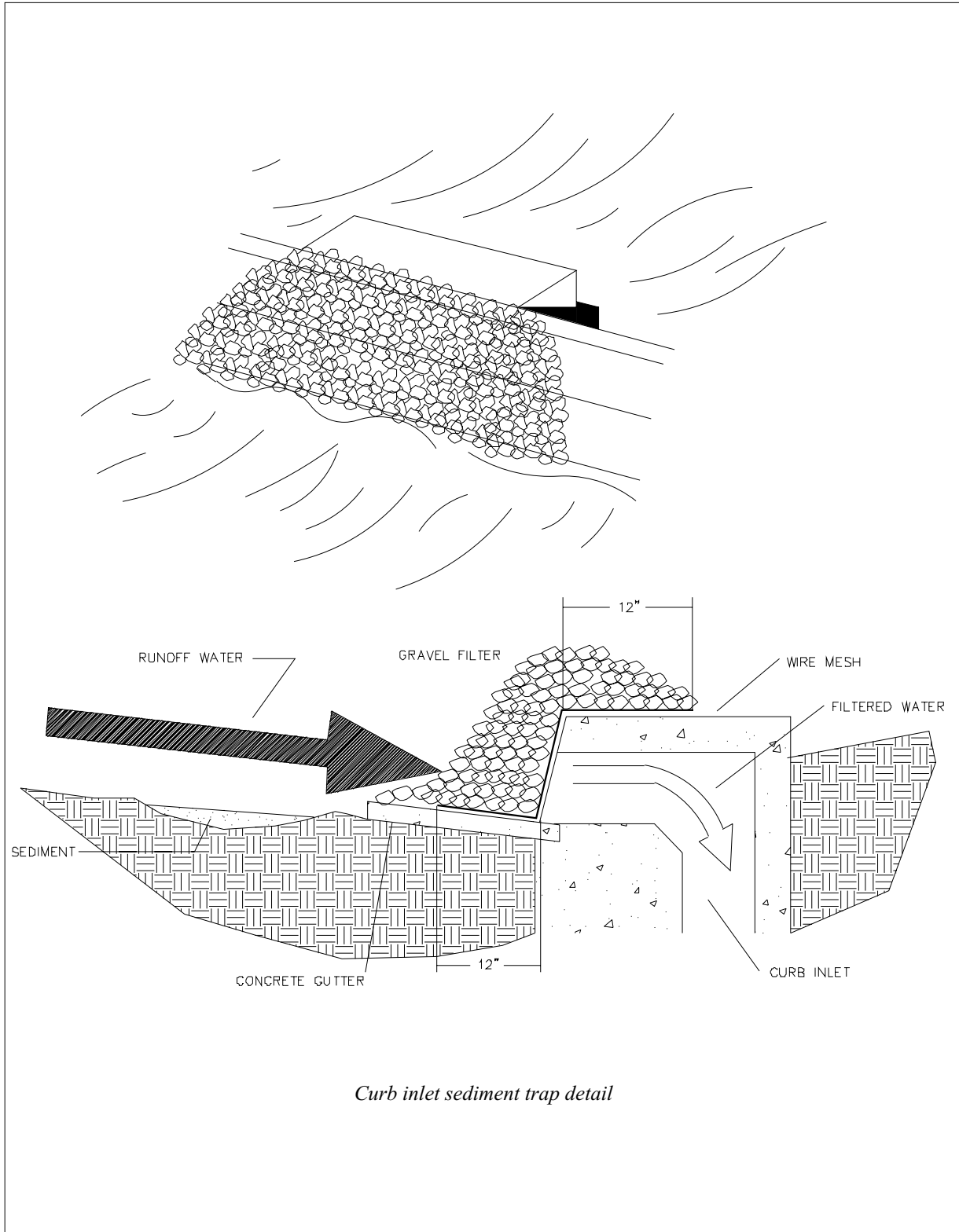





*Curb inlet sediment trap detail*

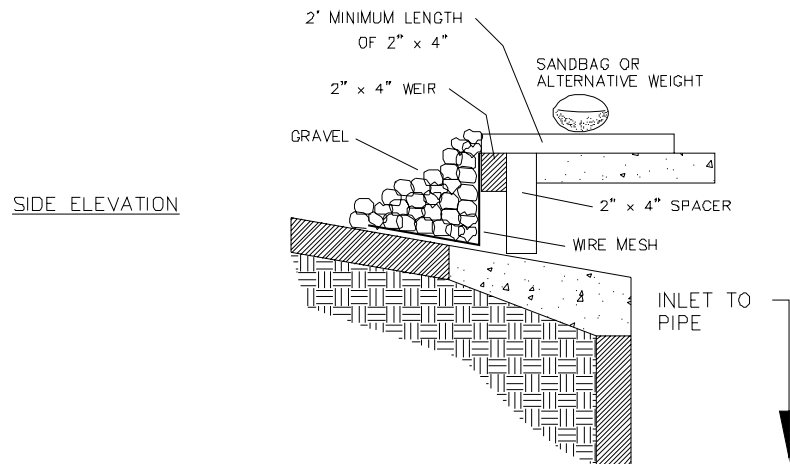
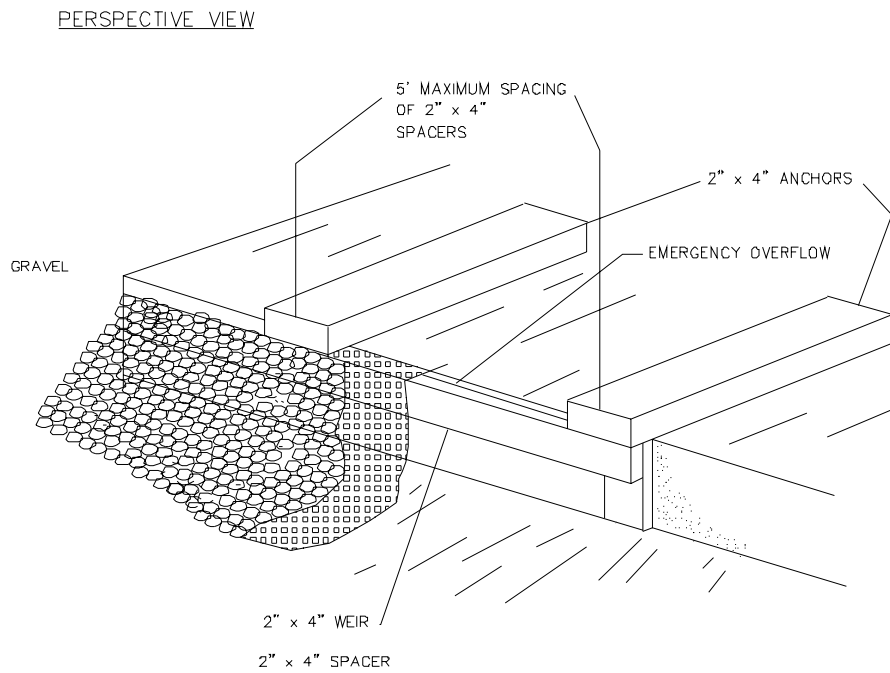

SPECIFIC APPLICATION

THIS IS APPLICABLE TO CURB INLETS WHERE A STURDY, COMPACT INSTALLATION IS DESIRED. EMERGENCY OVERFLOW CAPABILITIES ARE MINIMAL. EXPECT SIGNIFICANT PONDING WITH THIS MEASURE.



## **BMP DEWATERING**

---

### **DESCRIPTION**

**D**ewatering can be used to keep water from a work area by using any or all of the following: pump, barrier, vector, or bypass culvert.

### **PURPOSE**

The purpose of this BMP includes, but is not limited to:

- Allowing work to be performed in dewatered conditions.
- Reducing the transport of soil particles by flowing water.
- Reducing the liquefaction of soils.

### **APPLICATIONS**

This BMP may be used in, but not limited to, ditches, watercourses or streams, channels, swales and excavations. It will generally be used in combination with other BMPs.

### **LIMITATIONS**

This BMP should not be used:

- Where flows are greater than pump capacity.

### **CONSTRUCTION GUIDELINES**

- Determine if the project will require continuous dewatering.
- Schedule pumping, monitoring, equipment and maintenance activities accordingly.
- Dewatering must be used in accordance with applicable design and/or permit conditions.
- Refer to Appendix E for Fish Exclusion Protocols.
- Install a "Keep Water from Work Area" BMP.
- Install dewatering devices.
- Install site specific barrier, prior to dewatering, to prevent exterior water from entering construction area.
- Ensure water discharged from the site reduces erosion.



- Dewatered water will be discharged to:
  - A containment device.
  - A sanitary sewage system.
  - Other BMPs to reduce water borne soil particles prior to the water being reintroduced to a storm drainage system, water course or stream.

### **BMP MAINTENANCE**

- Schedule pumping, monitoring, equipment and maintenance activities in accordance with dewatering needs.
- During construction, inspect BMPs daily during the workweek. Schedule additional inspections during storm events. Make any required repairs as needed.
- Inspect bypass, pump, and barrier periodically. Make necessary repairs.
- Check for erosion at discharge. Repair or move as necessary.
- Have adequate fuel supply and backup pumps in the event of mechanical failure.

### **BMP REMOVAL**

- Remove BMP (recycle and/or re-use if applicable).
- Reintroduce water gradually.
- Re-vegetate area disturbed by BMP removal (if applicable).



## **BMP** **DIAPER NETTING**

### **DESCRIPTION**

**D**iaper/netting is a fine mesh netting or canvas suspended under a bridge, pipeline or pier to catch debris during construction or maintenance activities.

### **PURPOSE**

The purpose of this BMP includes, but is not limited to:

- Catching and containing falling debris (such as: concrete, wood chips, sawdust, slag and metal) from entering water during construction, maintenance and repair activities.

### **APPLICATIONS**

This BMP is used in bridge, pipeline or pier construction and repairs. It may also be used in maintenance activities such as cleaning and painting. It may be used in combination with other BMPs.

### **LIMITATIONS**

This BMP should not be used:

- During periods of high winds that reduce the effectiveness of the BMP.

### **CONSTRUCTION GUIDELINES**

- Multiple nets with different mesh sizes may be required, depending upon the work tasks performed. Mesh size gets progressively smaller from top to bottom.
- Attach diaper/netting securely prior to starting work.
- Remove diaper/netting carefully after work, not allowing debris to fall.
- Maintain separation between diaper/netting and water surface.

### **BMP MAINTENANCE**

- During construction, inspect BMPs daily during the workweek. Schedule additional inspections during storm events. Make any required repairs.
- Crew must provide progressive clean up of debris during the day.



---

## BMP REMOVAL

- Evaluate site to determine BMP is no longer needed.
- Remove debris on BMP.
- Remove BMP (recycle and/or re-use if applicable).
- Inspect after job is complete to make sure diaper/netting is in good repair for next project.



*Diaper netting under bridge*



*Netting with suspended framework*



## **BMP DITCH LINING**

---

### **DESCRIPTION**

**D**itch lining provides a long/short-term erosion resistant lining of the ditch flow line and side slopes utilizing biodegradable or non-biodegradable geo-textile fabrics and/or angular rock to stabilize ditches and channels from erosion and soil particle movement.

### **PURPOSE**

The purpose of this BMP includes, but is not limited to:

- Protecting the soil from erosive forces of concentrated runoff.
- Slowing the velocity of concentrated runoff while enhancing the potential for infiltration and vegetation growth.
- Stabilizing slopes adjacent to ditches which have seepage problems and/or non-cohesive soils.

### **APPLICATIONS**

This BMP may be used in ditches, channels, swales and banks or slopes. It may be used in conjunction with other BMPs.

### **LIMITATIONS**

This BMP should not be used directly in water courses unless required by permit.

### **CONSTRUCTION GUIDELINES**

- When used in watercourses or streams, this BMP must be used in accordance with permit requirements.
- Plan for site specific uses.
- Use design specifications when available.
- Channels should be constructed with a wide and shallow cross section.

### **BMP MAINTENANCE**

- During the initial establishment, inspection should occur and any necessary repair made.



- Grass seed should be applied in accordance with manufacturer specifications.
- After implementation, the channel should be inspected periodically to determine if channel is withstanding flow velocities without damage.
- Check the channel for debris, scour, or erosion and make necessary repairs.
- Remove all significant sediment accumulations to maintain the desired flow line and capacity during maintenance activity.
- Check channel slopes, outlets and all road crossings for bank stability and evidence of erosion, during maintenance activity, and make repairs as necessary.

#### **BMP REMOVAL**

- Evaluate site to determine BMP is no longer needed (the area has stabilized—potential of sediment laden water exiting the area has passed).
- Remove BMP (recycle and/or re-use if applicable).
- BMP removal is not always necessary.



## **BMP DIVERSION BERM**

### **DESCRIPTION**

A diversion berm is a temporary ridge of compacted soil constructed at the top or base of a disturbed slope.

### **PURPOSE**

The purpose of this BMP includes, but is not limited to:

- Diverting storm runoff from upslope drainage areas away from unprotected disturbed areas and toward a stabilized outlet.
- Diverting sediment-laden runoff from a disturbed area to a sediment-containment facility such as a sediment trap or a sediment basin.

### **APPLICATIONS**

This BMP may be used wherever stormwater runoff must be temporarily diverted away from a disturbed slope and toward a sediment containment facility. These structures generally have a life expectancy of 18 months or less. This BMP may be used in combination with other BMPs.

### **LIMITATIONS**

This BMP should not be used:

- If water flow is likely to erode the berm.
- If there is inadequate space for construction.

### **CONSTRUCTION GUIDELINES**

- Berms should be installed as a first step in the land-disturbing activity.
- The berm should be adequately compacted to reduce failure.
- Minimum freeboard can be 0.3 feet.
- Temporary seeding and mulch can be applied to the berm following construction of the berm.
- Clear plastic may be used as an additional erosion control method. See "Plastic Covering" BMP construction guidelines.

### **BMP MAINTENANCE**

- During construction, inspect BMPs daily during the workweek.





Schedule additional inspections during storm events. Make any required repairs.

- During long term implementation inspect once every two weeks, whether a storm has occurred or not.

### **BMP REMOVAL**

- Evaluate site to determine BMP is no longer needed (the area has stabilized—potential of sediment laden water exiting the area has passed).
- Remove sediment buildup.
- Remove BMP (recycle and/or re-use if applicable).
- Re-vegetate area disturbed by BMP removal (if applicable).

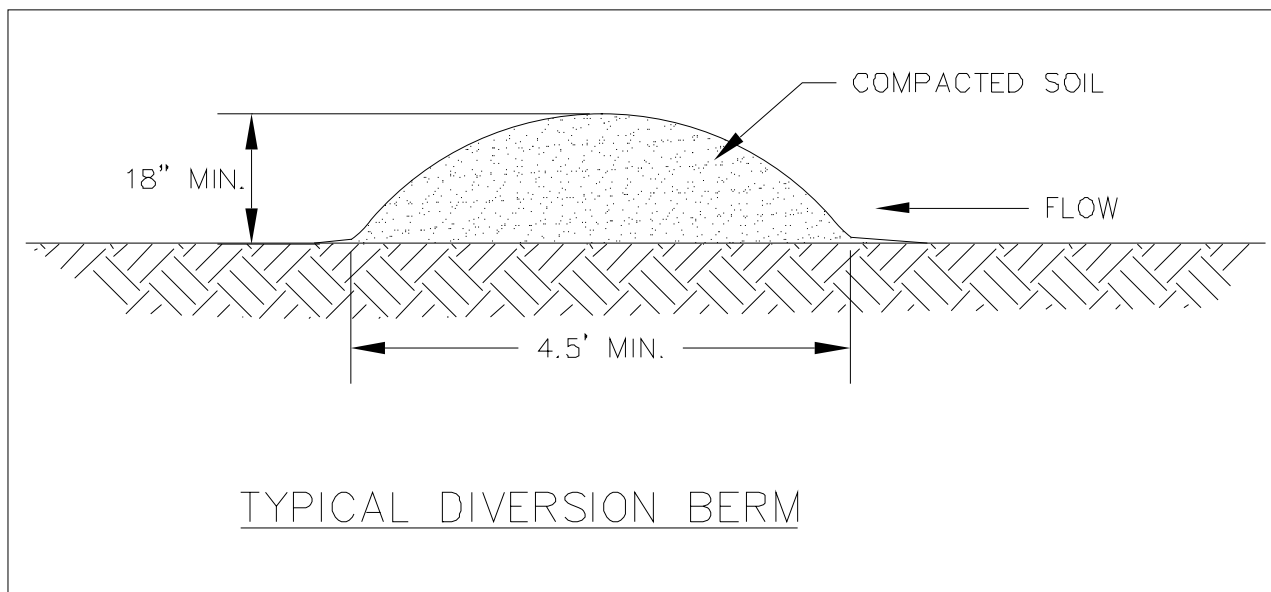

*Diversion berm detail*



## **BMP DIVERSION CHANNEL**

---

### **DESCRIPTION**

A diversion channel is constructed across a slope with a supporting earthen ridge on the lower side.

### **PURPOSE**

The purpose of this BMP includes, but is not limited to:

- Reducing slope length.
- Intercepting and diverting stormwater runoff to stabilized outlets at non-erosive velocities.
- Intercepting sheet flow.
- Decreasing down slope sheet flow velocity.

### **APPLICATIONS**

This BMP may be used where runoff from areas of higher elevation may damage property, cause erosion, or interfere with the establishment of vegetation on downslope areas. It may also be used where surface and/or shallow subsurface flow is damaging a slope and where the slope length needs to be reduced to minimize soil loss. This BMP may be used in combination with other BMPs.

### **LIMITATIONS**

This BMP should not be used:

- If the downslope is greater than 2 horizontal by 1 vertical.
- If water flow is likely to erode the channel.
- If there is inadequate space for construction.

### **CONSTRUCTION GUIDELINES**

- The diversion channel shall be excavated or shaped to line, grade and cross-section as required:
  - Side slopes of the channel shall be no steeper than 2 horizontal by 1 vertical.
  - Minimum freeboard shall be 0.3 feet.
- Compact fill material as needed to prevent unequal settlement.



- Temporary seeding and mulch can be applied to the channel following construction of the channel.
- Clear plastic may be used as an additional erosion control method. See "Plastic Covering" BMP construction guidelines.

### **BMP MAINTENANCE**

- During construction, inspect BMPs daily during the workweek. Schedule additional inspections during storm events. Make any required repairs.
- Seeded areas which fail to establish a vegetative cover shall be reseeded as necessary.
- During long term implementation inspect periodically, whether a storm has occurred or not.

### **BMP REMOVAL**

- Evaluate site to determine BMP is no longer needed (the area has stabilized—potential of sediment laden water exiting the area has passed).
- Remove sediment buildup.
- Remove BMP (recycle and/or re-use if applicable).
- Re-vegetate area disturbed by BMP removal (if applicable).



BMP: DIVERSION CHANNEL (continued)

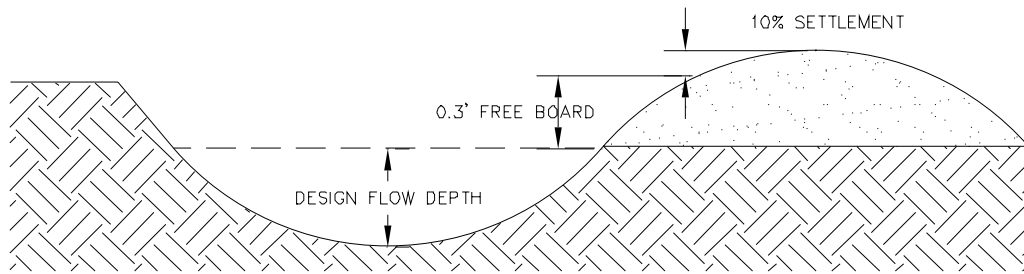

TYPICAL PARABOLIC DIVERSION

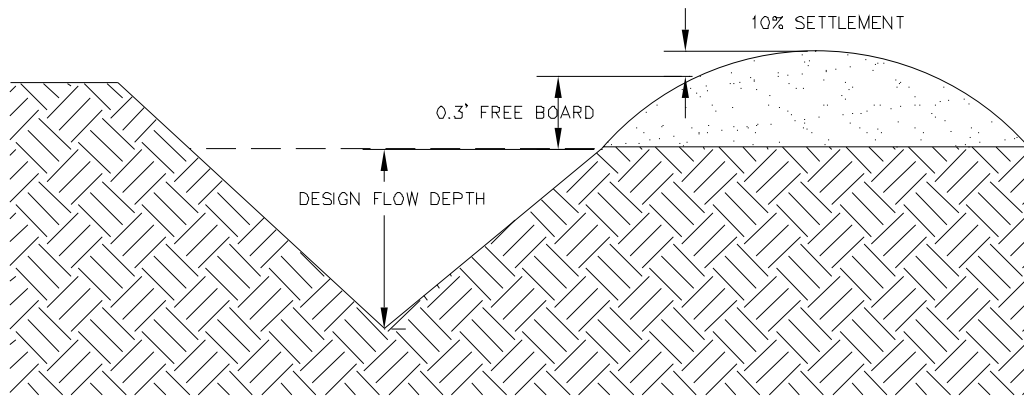

TYPICAL V-SHAPED DIVERSION

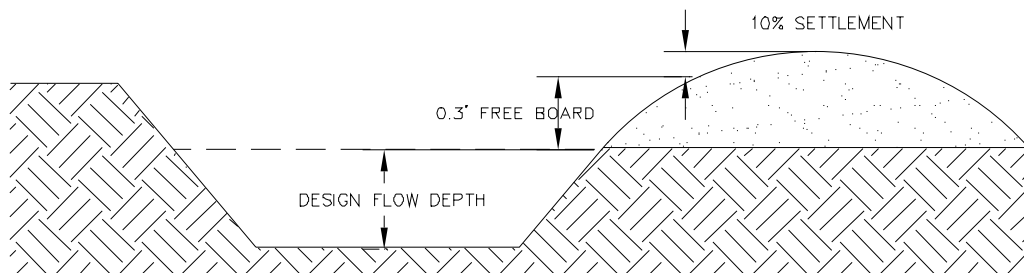

TYPICAL TRAPEZOIDAL DIVERSION



---

### DESCRIPTION

**D**ust control is the use of water, products, and/or measures for reducing wind erosion. Particles moved by wind may cause air pollution, soil loss and/or water quality degradation.

### PURPOSE

The purpose of this BMP includes, but is not limited to:

- Reducing soil particle travel by wind due to construction or maintenance operation activities.
- Reducing air and water pollution.

### APPLICATIONS

This BMP may be used on construction sites, roads, shoulders, operating headquarters or pit/quarry sites. It may be used in combination with other BMPs. Protecting the soil surface is accomplished through measures such as roughening the soil to reduce the surface wind velocity, applying straw/mulch, water, matting, hydroseeding, plastic covering, Lignum derivative, or Magnesium Chloride.

### LIMITATIONS

This BMP should not be used:

- With straw in locations where compaction is required (for example, roadway shoulders or road bases).
- If a chemical suppressant could enter watercourses or streams.

### CONSTRUCTION GUIDELINES

- Water, Lignum derivative, or Magnesium Chloride can be applied by mechanical means.
- A temporary straw covering may be applied by hand to a small area of exposed soil where compaction is not required.
- Surface roughening may be accomplished by using a machine.
- Create a berm downslope to control possible runoff from watering.



### **BMP MAINTENANCE**

- During the construction period, inspect BMPs daily during the workweek. Make any required repairs.
- Reapply BMP as needed.

### **BMP REMOVAL**

- Evaluate site to determine BMP is no longer needed (the area has stabilized—potential of wind erosion has passed).
- Straw removal may be necessary if the area is to be re-vegetated.
- Re-vegetate area disturbed by BMP removal.



*Water wagon wetting down field for dust control*



*Wetting down stockpiles to reduce airborne soil particles*

# BMP

## EXCELSIOR FILLED LOG



---

### DESCRIPTION

An excelsior filled log is a manufactured log filled with curled wood excelsior. When cut or folded to appropriate length, these logs can be used to provide filter/perimeter protection, settling, reduction in water velocity/erosive forces and habitat protection/maintenance.

### PURPOSE

The purpose of this BMP includes, but is not limited to:

- Reducing slope length to capture and retain sediment on the slope.
- Temporarily stabilizing slopes by reducing soil creep, sheet and rill erosion until permanent vegetation can be established.
- Trapping topsoil and retaining moisture from rainfall, which aids in growth of seedlings planted along the upslope side of the rolls.
- Intercepting and detaining small amounts of water from disturbed areas during construction operations in order to promote settling of soil particles.
- Filtering soil particles and debris.
- Reducing water velocity and erosive forces.

### APPLICATIONS

This BMP may be used in ditches or across culvert ends of any dimension. Excelsior filled logs may also be used for habitat protection at the toe of a bank and can be incorporated with vegetative planting. It may be used instead of straw logs, coir logs, or straw bale filtering systems. Excelsior filled logs may also be used for perimeter sediment control.

This BMP may be used in gullies and stream channels as check dams in conjunction with gabions, rip rap, articulated block, or cellular confinement systems. It may be used to anchor and enhance the effectiveness of willow wattles (fascines), turf reinforcement mats, coir mats, continuous berms and other erosion control material. Excelsior filled logs may be used to replace silt fences or straw bales on steep slopes. It may be used in combination with other BMPs.



---

## LIMITATIONS

This BMP should not be used:

- Where flow volume or velocity inhibit BMP function.
- For long term applications.
- When maintenance activities conducted in locations could reduce actual or potential high flow salmonid refuge functions, this BMP will be used if required by permit conditions.

## CONSTRUCTION GUIDELINES

- Excelsior filled log must be placed in accordance with applicable design and/or permit conditions.
- Logs are placed and staked along the contour of newly constructed or disturbed slopes, in 2-3 inch deep trench.
- Spacing depends on soil type and slope steepness.
- Tightly abut any adjacent logs.
- Install to prevent water from going around or under BMP.
- See "Live Staking", "Handseeding" and/or "Hydroseeding" BMP for planting.

## BMP MAINTENANCE

- During construction, inspect BMPs daily during the workweek. Schedule additional inspections during storm events. Make any required repairs.
- Sediment should be removed when deposits reach one-half the height of the BMP.

## BMP REMOVAL

- Evaluate site to determine BMP is no longer needed (the area has stabilized—potential of sediment laden water exiting the area has passed).
- Remove sediment buildup in front of BMP.
- Depending upon BMP placement, re-vegetation of site may be necessary.
- BMP removal may not be necessary.



# **BMP FILTER FABRIC**



---

## **DESCRIPTION**

**F**ilter fabric is a permeable material made with synthetic fibers. It may be a woven or non-woven fabric and is usually packaged in roll form. This fabric can be used to reduce potential for soil becoming water borne, filter/perimeter protection and/or settling.

## **PURPOSE**

The purpose of this BMP includes, but is not limited to:

- Filtering soil particles from water.
- Stabilizing and reinforcing soils.

## **APPLICATIONS**

This BMP may be used in drainage filtration, to reinforce paved and unpaved roads, stabilize access or haul roads and to separate soils.

## **LIMITATIONS**

This BMP should not be used:

- In the streambed of a channel.
- When short term biodegradability is required.

## **CONSTRUCTION GUIDELINES**

- When used near watercourses or streams, this BMP must be used in accordance with permit requirements.
- Some applications may be designed or reviewed by an engineer.
  - Woven filter fabric should only be used for soil separation, road reinforcement and soil separation.
  - Non-woven filter fabric should only be used for drainage filtration although it may be used under unpaved roads in certain circumstances.
  - Use according to manufacturers details.

## **BMP MAINTENANCE**

- During construction, inspect BMPs daily during the workweek.



Schedule additional inspections during storm events. Make any required repairs.

### **BMP REMOVAL**

- Evaluate site to determine BMP is no longer needed (the area has stabilized—potential of sediment laden water exiting the area has passed).
- If used as a filter, remove sediment buildup from in front of the BMP.
- Re-vegetate area disturbed by BMP removal (if applicable).
- BMP removal may not be necessary when it is part of the final structure.

# **BMP**

## **GRASS LINED CHANNEL**



---

### **DESCRIPTION**

A grass lined channel is the vegetative lining of a ditch, watercourse, stream, or swale to protect it from erosion and to provide filter/perimeter protection.

### **PURPOSE**

The purpose of this BMP includes, but is not limited:

- Reducing erosion by providing ground cover, binding soil particles with roots, and lowering water velocity.
- Providing filter/perimeter protection.
- Providing habitat for primary production.
- Providing habitat for prey base organisms such as macro-invertebrates.

### **APPLICATIONS**

This BMP may be used where a vegetative lining can provide sufficient stability for the channel grade by decreasing velocity; where site conditions require establishment of vegetation (climate, soil and topography are present). This BMP may be used in combination with other bank stabilizing methods.

### **LIMITATIONS**

This BMP should not be used:

- When maintenance activities are conducted in locations which could reduce actual or potential high flow salmonid refuge functions.
- In locations where there is frequent turbulence with flows likely to rip out grass lining, creating erosion and downstream plugging of system.

### **CONSTRUCTION GUIDELINES**

- This BMP must be used in accordance with applicable permit requirements.



### **BMP MAINTENANCE**

- During initial vegetation establishment, inspection should occur and any necessary repairs made.
- After vegetation establishment, the channel should be inspected periodically to determine if the channel is withstanding flow velocities without damage.
- Check the channel for debris, scour, or erosion and make repairs.
- Remove all significant sediment accumulations to maintain the designed carrying capacity. Debris such as litter, car parts, appliances and items that pose a risk to public safety should be removed. Any LWM that falls into the channel and does not pose a threat to public safety or structure damage should be left in place or relocated to an area that is not a public safety hazard or ROW structure problem.

- Check channel outlet and all road crossings for bank stability, evidence of piping or scour holes and make repairs.

### **BMP REMOVAL**

- BMP removal is not necessary.



*Grass lined channel: reducing erosion by providing ground cover*



*Grass lined channel: providing a filter*

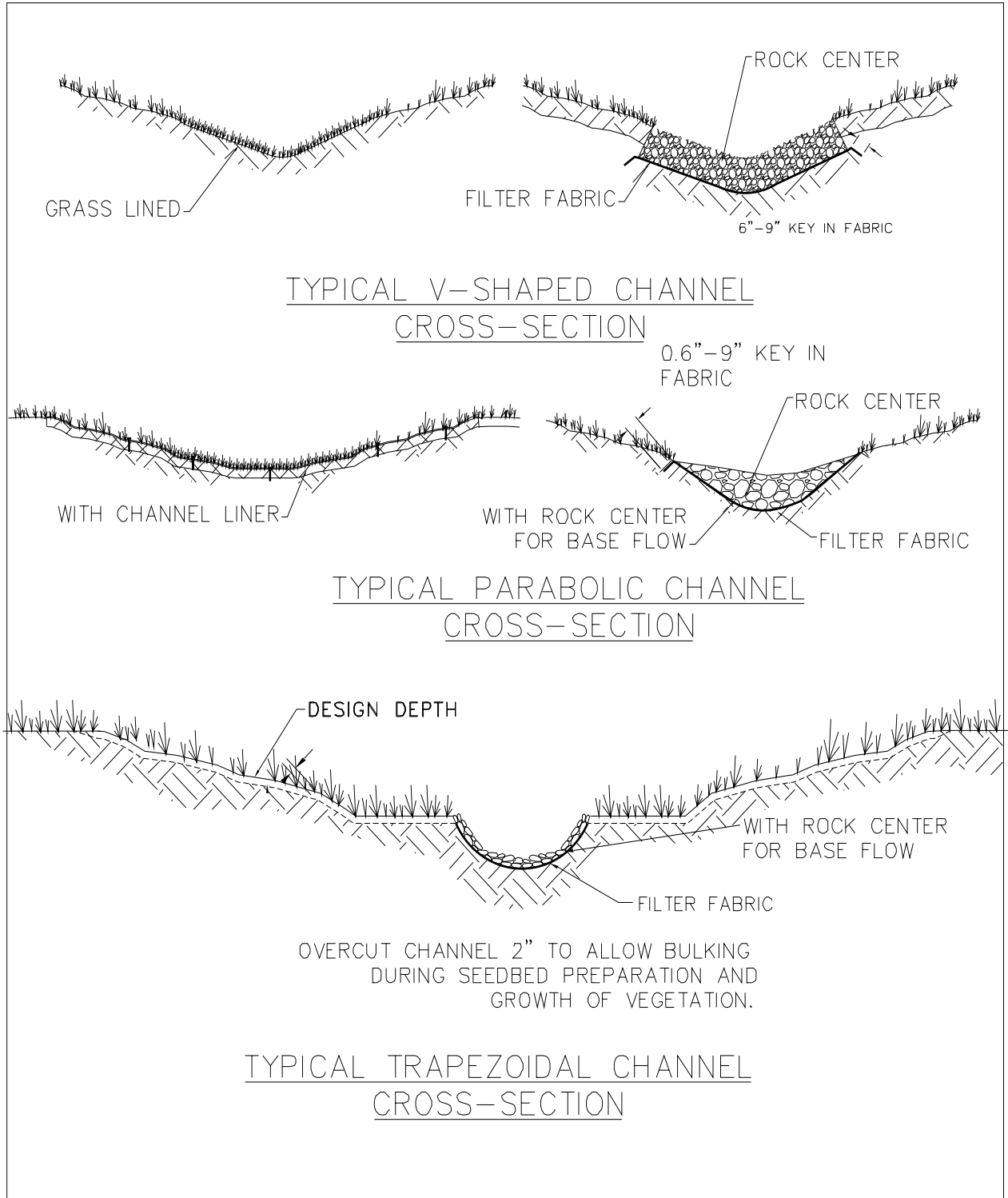



BMP: GRASS LINED CHANNEL (continued)

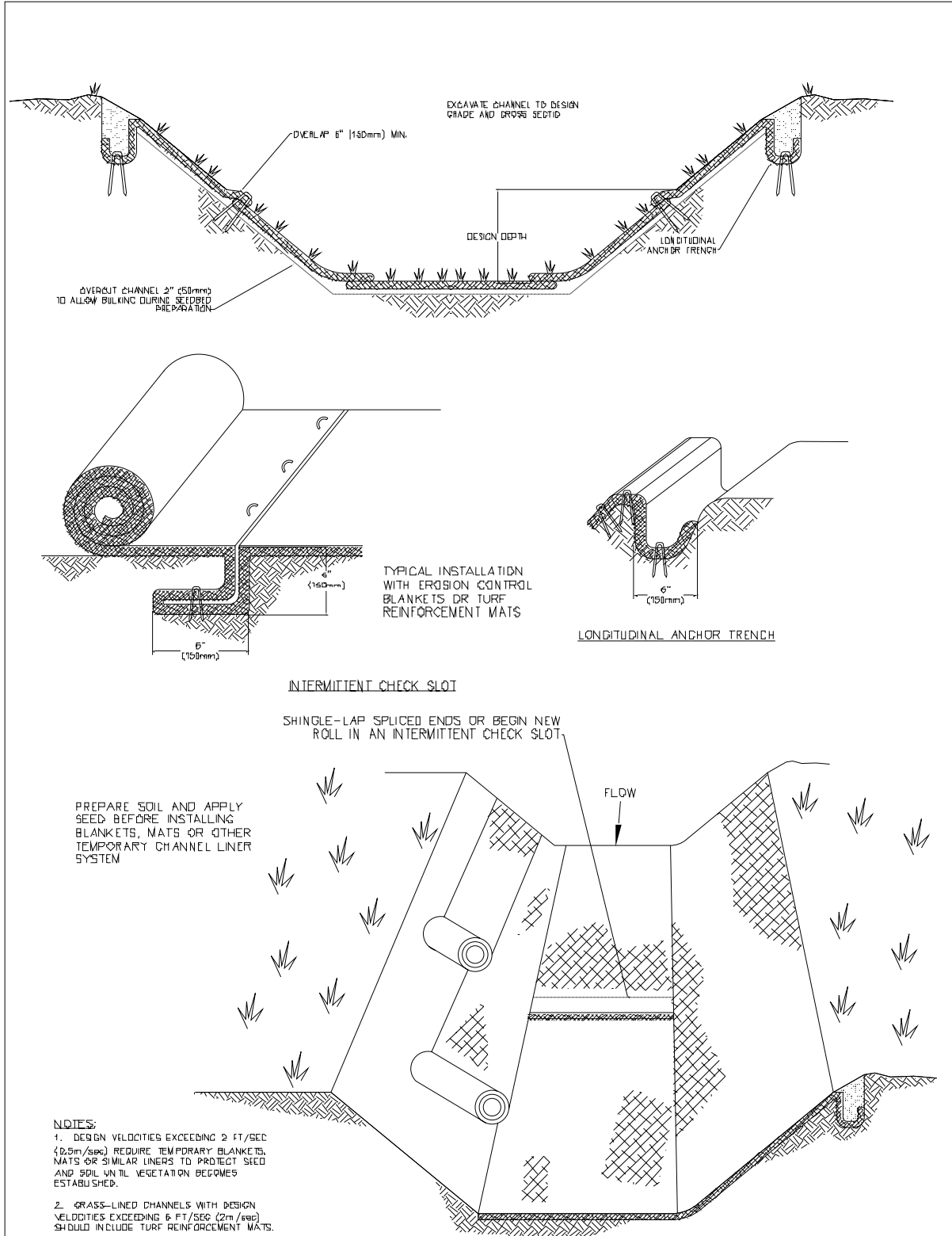

# BMP

## GRAVEL FILLED SUMP



---

### DESCRIPTION

A gravel filled sump is a constructed sump filled with gravel and a standing perforated pipe or bucket that allows pumping filtered water out of a non-erosive location.

### PURPOSE

The purpose of this BMP includes, but is not limited to:

- Dewatering construction sites.
- Filtering sediment from water.

### APPLICATIONS

This BMP is used in conjunction with flow bypass.

### LIMITATIONS

This BMP should not be used:

- When peak flows exceed the pump capacity.

### CONSTRUCTION GUIDELINES

- Excavate hole at least 3 feet deep.
- Line the base and sides of the hole with filter fabric.
- Place perforated pipe inside the hole.
- Shore up pipe by adding washed rock to space between hole and pipe exterior.
- Have adequate fuel supply and backup pumps in the event of mechanical failure.

### BMP MAINTENANCE

- Inspect bypass, pump, and sump periodically. Repair any leaks immediately.
- Check for scour at bypass outfall. Repair or move as necessary.
- Provide downstream sediment filtration.

### BMP REMOVAL

- Remove BMP when in water work is complete.
- Remove BMP (recycle and/or re-use if applicable).
- Re-vegetate area disturbed by BMP removal (if applicable).



## **BMP HALF ROUND FILTER**

---

### **DESCRIPTION**

The half round filter BMP is one-half section of perforated pipe cut lengthwise (with optional filter fabric lining) and filled with washed rock.

### **PURPOSE**

The purpose of this BMP includes, but is not limited to:

- Filtering sediment from water.
- Reducing water velocity.

### **APPLICATIONS**

This BMP may be used at construction sites to filter sediment-laden water pumped from construction area. This BMP may be used with other sediment control BMPs.

### **LIMITATIONS**

This BMP should not be used:

- In fast flowing water.
- To filter water with a high percentage of fines.
- As the sole BMP.

### **CONSTRUCTION GUIDELINES**

- Make sure pump head (if used) is secured within washed rock.
- Make sure length of pipe and amount of rock is sufficient for site.
- Have additional washed rock available on site.
- Have adequate fuel supply and backup pumps in the event of mechanical failure.

### **BMP MAINTENANCE**

- Evaluate half round filter and pump (if used) periodically to ensure BMP is functioning properly.
  - Check for scour at outfall.
  - Check outlet to make sure water is running clear. If not, add washed rock.
-





BMP: HALF-ROUND FILTER (continued)

---

### **BMP REMOVAL**

- Evaluate site to determine BMP is no longer needed (the area has stabilized—potential of sediment laden water exiting the area has passed).
- Remove sediment buildup.
- Remove BMP (recycle and/or re-use if applicable).
- Re-vegetate area disturbed by BMP removal (if applicable).



This page intentionally left blank.

---

# BMP HAND SEEDING



---

## DESCRIPTION

**H**and seeding is broadcasting grass seed on disturbed areas by hand or a hand seeding device. This BMP is used to reduce potential for soil becoming water or air borne, to reduce water velocity/erosive forces after vegetation establishment and to aid in habitat protection/maintenance.

## PURPOSE

The purpose of this BMP includes, but is not limited to:

- Establishing vegetation in sparse, bare and/or exposed soil areas.
- Decreasing soil erosion.

## APPLICATIONS

This BMP may be used after soil disturbance is completed at construction sites. This BMP may be used in areas that need to be permanently or temporarily vegetated. It may be used in conjunction with other BMPs.

## LIMITATIONS

This BMP should not be used:

- In months when seed germination will not occur. (In winter months, see "Mulching" and/or "Plastic Covering" BMPs).

## CONSTRUCTION GUIDELINES

- Seed mixes vary. Seed selection should be based on the intended use of the area it is applied to, for example, low growing grass versus ditch bank grass.
- Spread seed uniformly and according to manufacturer's recommendations.
- Cover with other methods as needed to protect surface (for example, light application of mulch, jute matting).

## BMP MAINTENANCE

- Inspect during seed establishment period. Re-seed, due to mortality, as necessary.
- Schedule additional inspections during storm events and/or heavy



BMP: HAND SEEDING (continued)

---

rainfall. Check for scour and sloughing; any required repairs shall be made.

**BMP REMOVAL**

- BMP removal is not necessary.

# BMP

## HYDROSEEDING



---

### DESCRIPTION

Hydroseeding is broadcasting grass seed, tackifier, wood fiber mulch and water on disturbed areas by using a hydroseeding machine. This BMP is used to reduce potential for soil becoming water or air borne, to reduce water velocity/erosive forces after vegetation establishment and to aid in habitat protection/maintenance.

### PURPOSE

The purpose of this BMP includes, but is not limited to:

- Establishing vegetation in sparse, bare and/or exposed soil areas over a large site.
- Decreasing soil erosion.

### APPLICATIONS

This BMP may be used after soil disturbance is completed at construction sites. This BMP may be used in areas that need to be permanently or temporarily vegetated. It may be used in conjunction with other BMPs.

### LIMITATIONS

This BMP should not be used:

- In months when seed germination will not occur. (In winter months, see "Mulching" and/or "Plastic Covering" BMPs).
- During strong winds or freezing weather.

### CONSTRUCTION GUIDELINES

- Seed mixes vary. Seed selection should be based on the intended use of the area it is applied to. For example low growing grass versus ditch bank grass.
- Spread seed uniformly and according to manufacturer's recommendations.
- Cover hydroseeded area with other methods as needed.
- Hydroseeding should be applied after finish grading and/or surface roughening. Application may depend on slope, soil, exposure and time of year.
- Tackifier and/or moisture retention agent may need to be added, per state



standard.

### **BMP MAINTENANCE**

- Inspect during seed establishment period. Re-seed, due to mortality, as necessary.
- Schedule additional inspections during storm events and/or heavy rainfall. Check for scour and sloughing; any required repairs shall be made.

### **BMP REMOVAL**

- BMP removal is not necessary.



*Erosion protection and vegetation establishment after maintenance work*

# BMP

## INLET PROTECTION



---

### DESCRIPTION

Inlet protection is a sediment filter located at the inlet to a storm drainage conveyance. It may be an external structure such as a filter fence box or a gravel berm. Inlet protection may also be an internal device such as a silt sock or a silt trap.

### PURPOSE

The purpose of this BMP includes, but is not limited to:

- Reducing soil particles from entering storm drainage systems.

### APPLICATIONS

This BMP may be used in ditches at the inlet to enclosed drainage systems. They may also be used in manholes or catch basins. This BMP may be used in combination with other BMPs.

### LIMITATIONS

This BMP should not be used:

- Where there are traffic conflicts.
- In areas where it creates excessive ponding.
- To remove excessive fines.

### CONSTRUCTION GUIDELINES

- Refer to sketches on following pages for details and specific construction guidelines.

### BMP MAINTENANCE

- During construction, inspect BMPs daily during the workweek. Schedule additional inspections during storm events. Make any required repairs.
- Sediment should be removed when deposits reach one-half the height of the BMP.



### **BMP REMOVAL**

- Evaluate site to determine BMP is no longer needed (the area has stabilized—potential of sediment laden water exiting the area has passed).
- Remove sediment buildup in front of BMP.
- Remove BMP (recycle and/or re-use if applicable).
- Re-vegetate area disturbed by BMP removal (if applicable).



*Inlet protection: filter fence surrounding catch basin to reduce soil particles from entering drainage system*





BMP: INLET PROTECTION (continued)

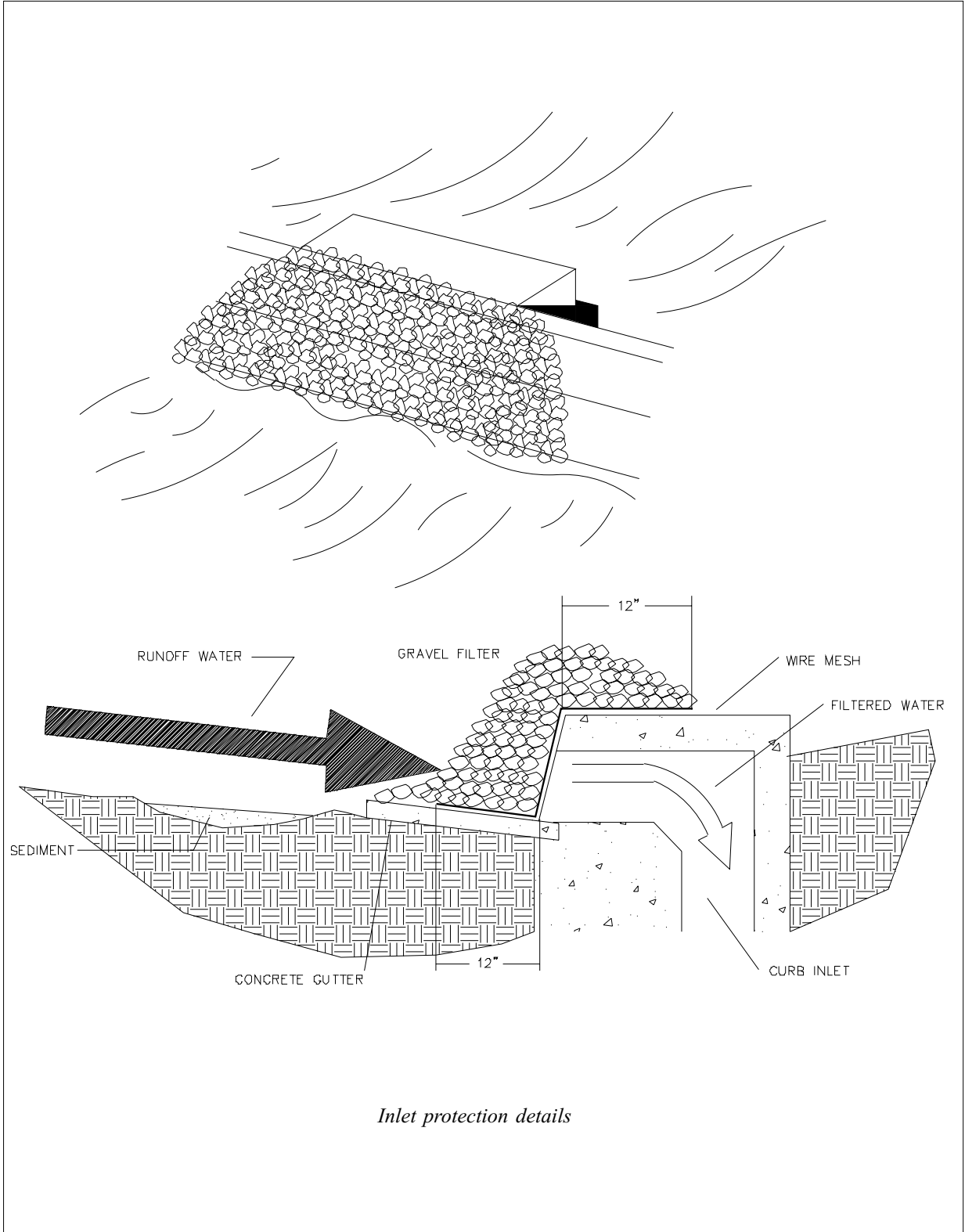

*Inlet protection details*



BMP: INLET PROTECTION (continued)

SILT FENCE DROP INLET PROTECTION

PERSPECTIVE VIEWS

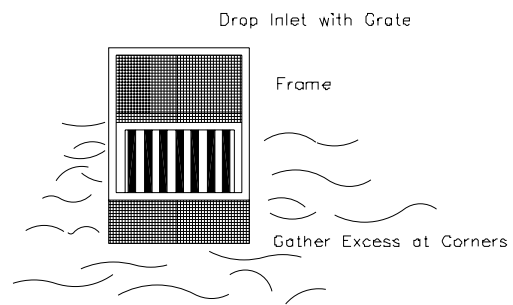
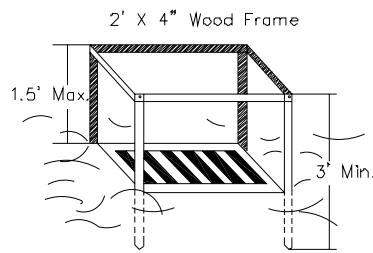

ELEVATION OF STAKE AND FABRIC ORIENTATION

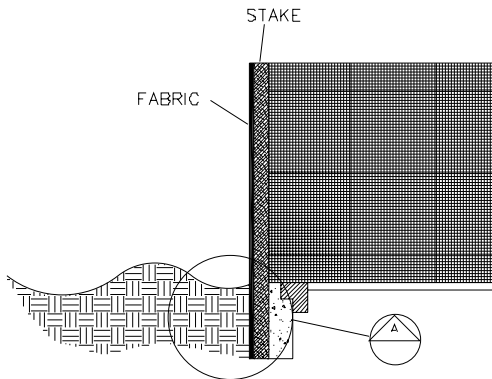

DETAIL A

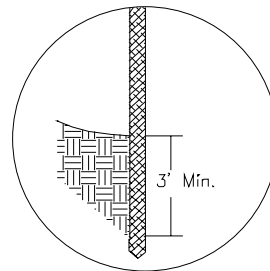

SPECIFIC APPLICATION

THIS METHOD OF INLET PROTECTION IS APPLICABLE WHERE THE INLET DRAIN IS A RELATIVELY FLAT AREA (SLOPE CANNOT EXCEED 5%). WHERE INLET SHEET OR OVERLAND FLOWS ARE TYPICAL AND CANNOT EXCEEDING 1 CFS. THIS METHOD SHALL NOT BE USED WHERE THE INLETS ARE RECEIVING CONCENTRATED FLOWS, SUCH AS IN STREETS OR HIGHWAY MEDIANS

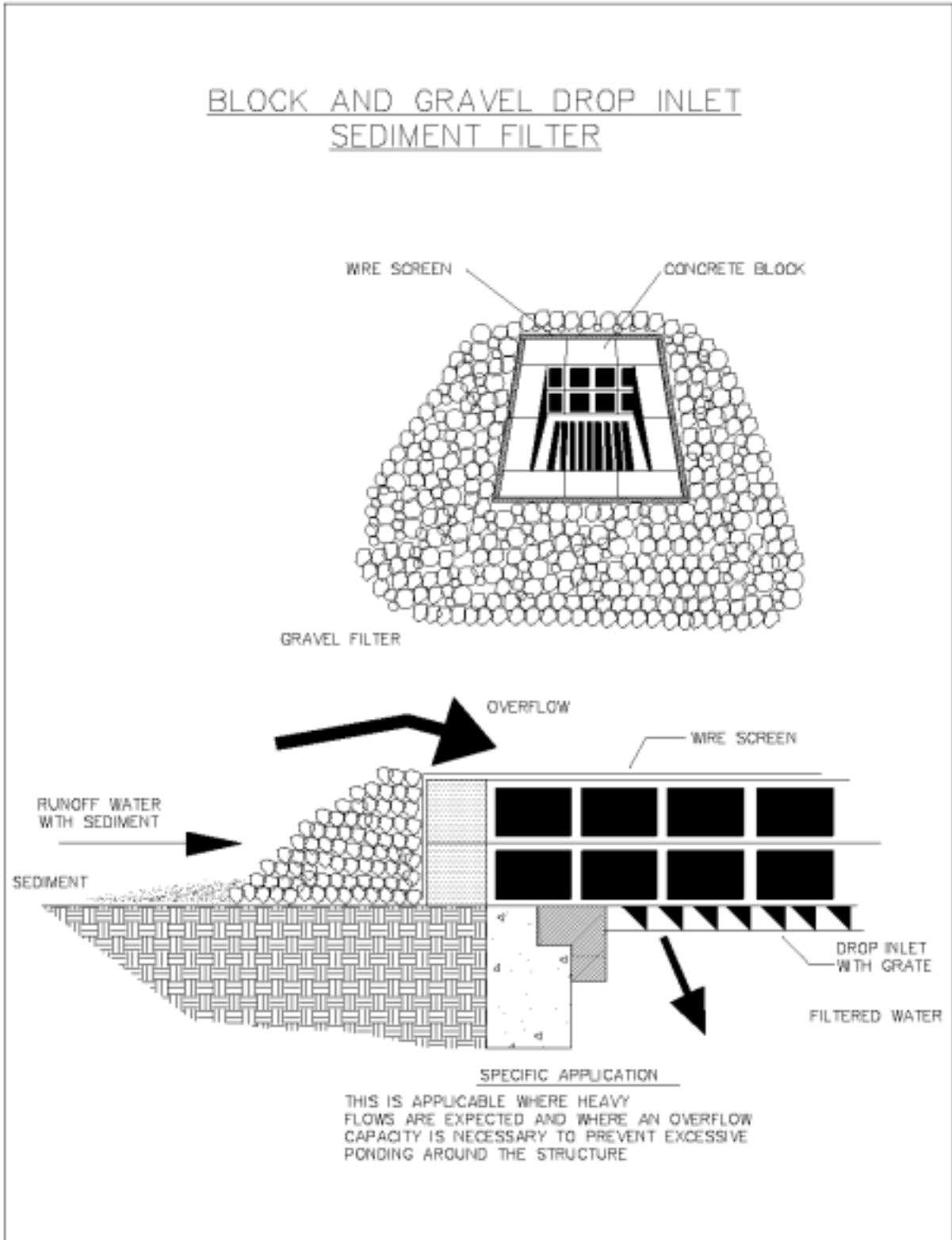



BMP: INLET PROTECTION (continued)

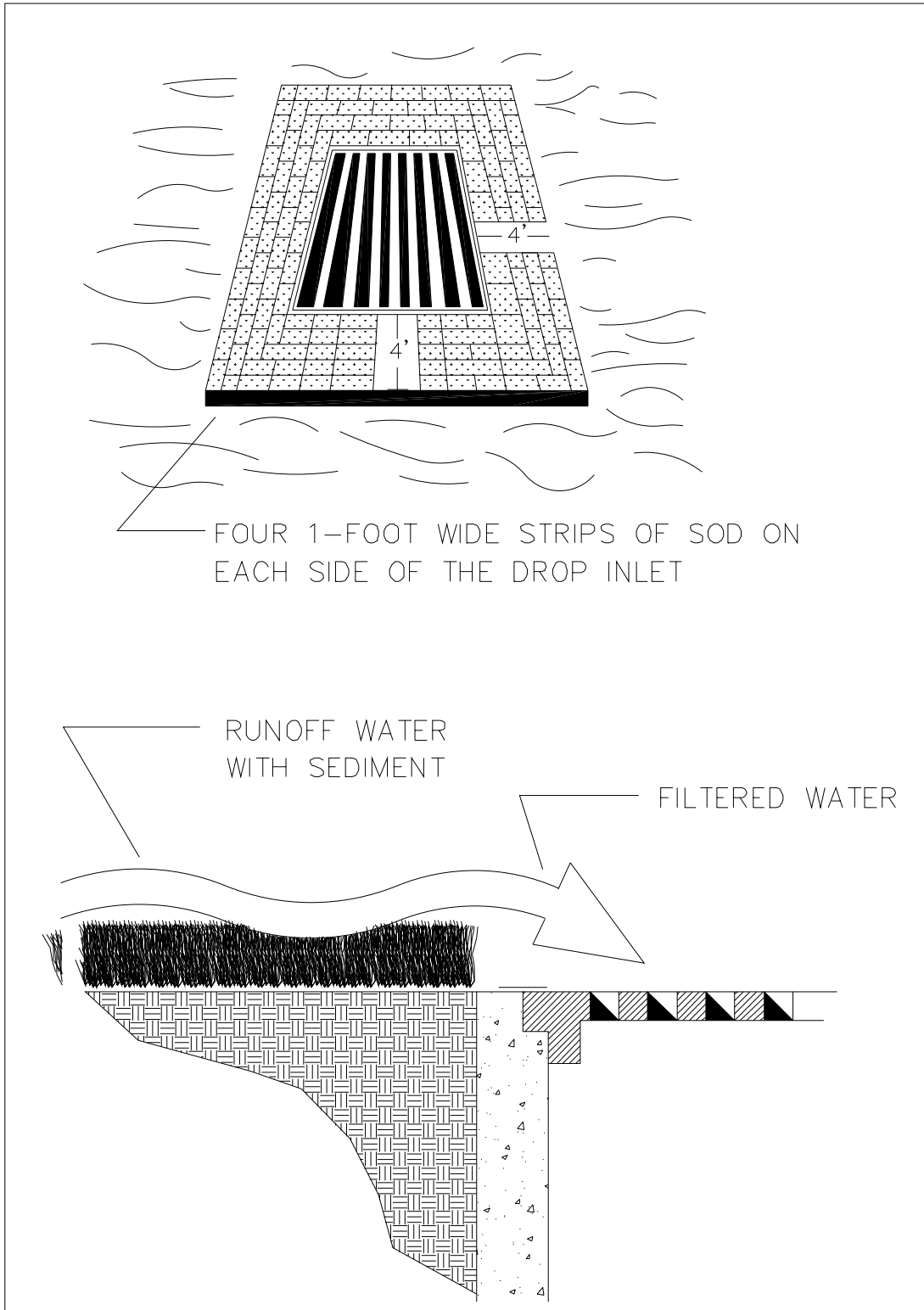

*Inlet protection detail*



BMP: INLET PROTECTION (continued)

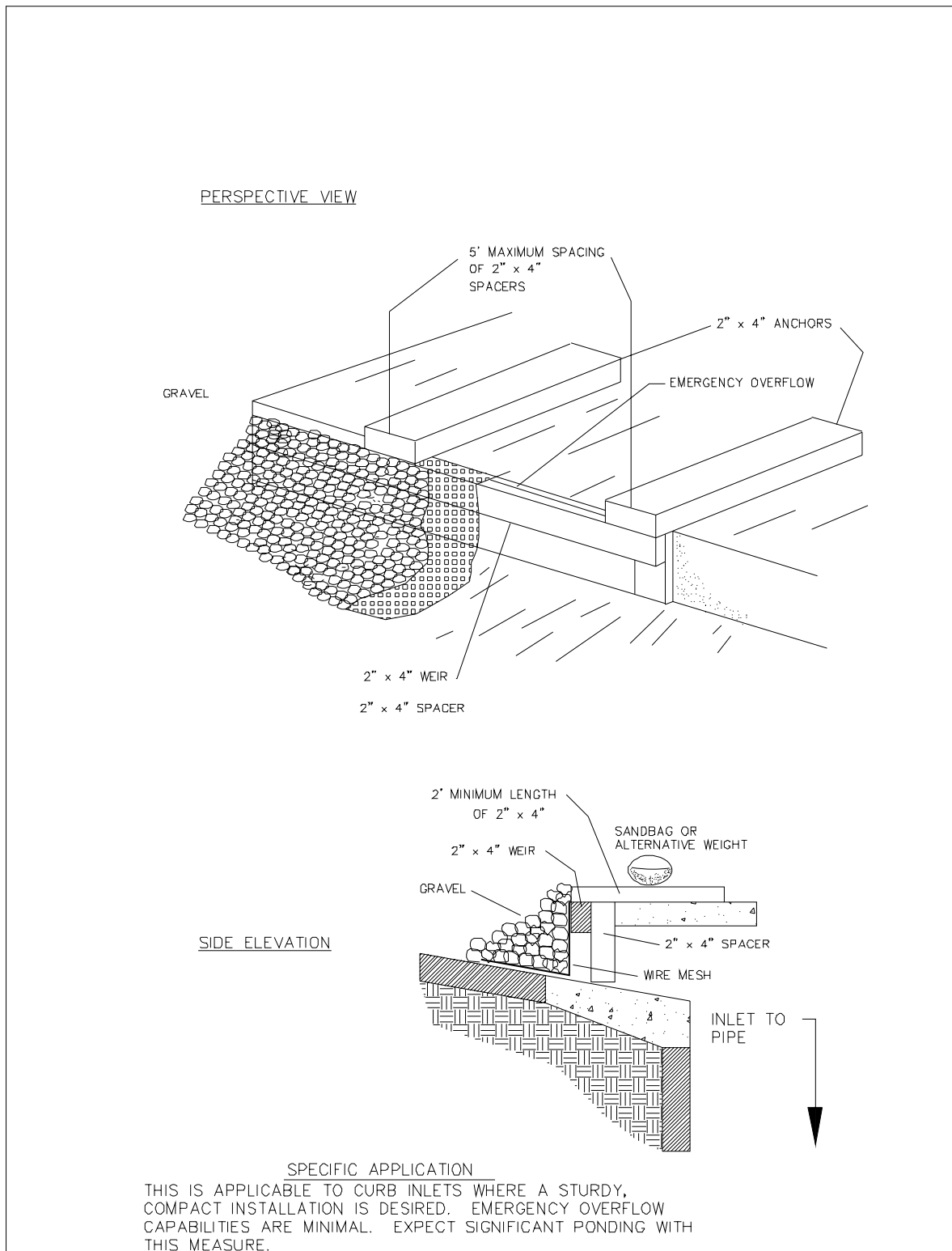

*Inlet protection detail*



## **BMP** **KIMBLE FILTER PIPE**

---

### **DESCRIPTION**

**A** Kimble filter is a perforated pipe (with an optional filter fabric wrap, depending on soil types) added to an existing inlet pipe, surrounded by washed rock.

### **PURPOSE**

The purpose of this BMP includes, but is not limited to:

- Filtering sediment from water entering existing pipe at construction area.

### **APPLICATIONS**

This BMP may be used in open drainage system maintenance and in conjunction with other BMPs.

### **LIMITATIONS**

This BMP should not be used:

- When the inlet elevation for the perforated pipe extension exceeds the surrounding bank height.
- To remove excessive fines unless the optional filter fabric is used.

### **CONSTRUCTION GUIDELINES**

- Secure perforated pipe onto existing pipe and wrap in filter fabric as needed.
- Fill washed rock high enough to ensure filtration.

### **BMP MAINTENANCE**

- Check outfall periodically. Revise methods if water is not running clear.

### **BMP REMOVAL**

- Evaluate site to determine BMP is no longer needed (the area has stabilized—potential of sediment laden water exiting the area has passed).
- Remove sediment buildup in front of BMP.
- Remove BMP (recycle and/or re-use if applicable).
- Re-vegetate area disturbed by BMP removal (if applicable).

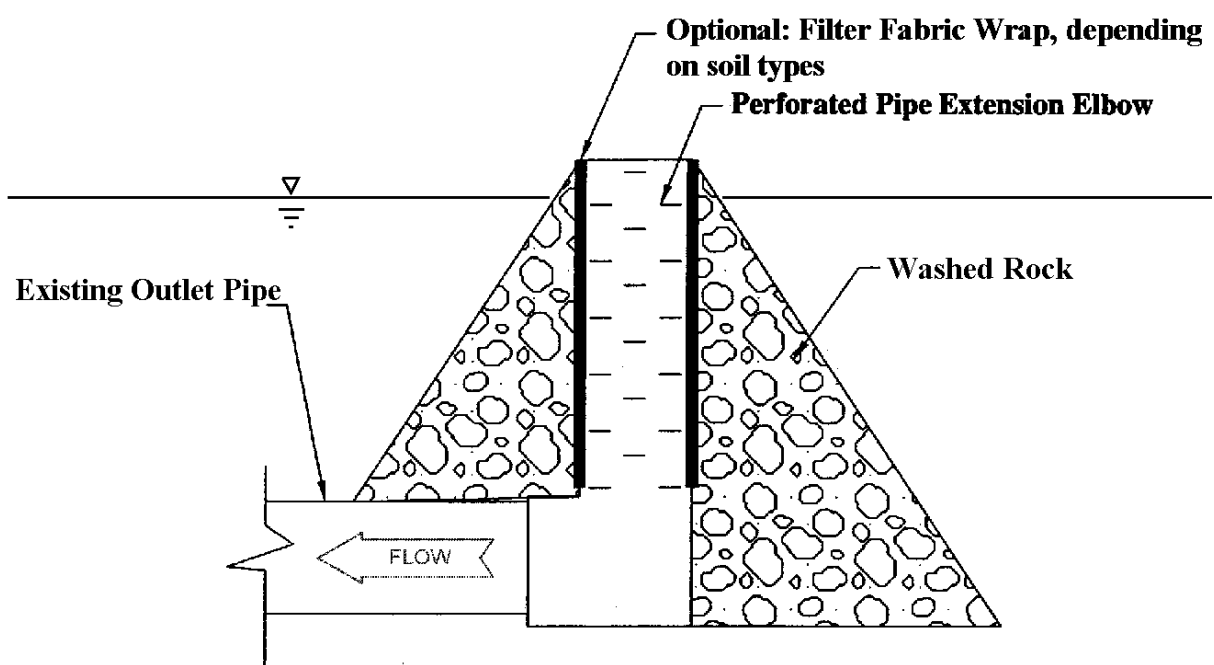

*Kimble filter detail*



## **BMP**

# **LARGE WOODY MATERIAL**

---

### **DESCRIPTION**

**L**arge Woody Material (LWM) is any large piece of woody material (including the trunk and root mass) that intrudes or is imbedded in the stream channel. Woody materials affects local flow velocities, streambed and streambank stability, and local stream characteristics. For example: see DOE, WDFW, and/or King County Bank Stabilization Guidelines. LWM is used to reduce water velocity/erosive forces and to provide habitat for fish.

### **PURPOSE**

The purpose of this BMP includes, but is not limited to:

- Improving aquatic habitat by re-directing flows away from eroding banks, providing cover, creating pools and storing sediment.
- Providing stream bed and bank stabilization.

### **APPLICATIONS**

When incorporating woody material into projects, it is necessary to identify the desired engineering performance and the desired habitat benefits. Each project must be specifically tailored to meet the engineering objectives identified for the habitat requirements of the target species. It can be used in combination with other BMPs.

### **LIMITATIONS**

This BMP should not be used:

- When the specific design requirements and desired habitat benefits have not been identified.
- Without consideration of the factors that influence the relative permanence of the wood in the stream channel.

### **CONSTRUCTION GUIDELINES**

- These will vary based on existing site conditions, design features, size and shape of the wood, its exposure to the forces exerted by moving water, and its resistance to movement because of wedging, or embedding with adjacent materials.





## BMP: LARGE WOODY MATERIAL (continued)

---

- Construct in accordance with design, specifications and permit conditions.

### **BMP MAINTENANCE**

- Monitor the large woody material to ensure it remains "as built" during construction.
- Consult a biologist for specific repairs.

### **BMP REMOVAL**

- BMP removal is not applicable.



*Large woody debris placed in streambed to provide salmonid refuge. Note use of streambed gravel, dewatering with pump, and mulching*



BMP: LARGE WOODY MATERIAL (continued)

---



*Large woody material placed in a streambed to provide salmonid refuge. Note use of turbidity curtain, streambed gravel, silt fence, coir fabric, mulching, and stream bypass*



*Large woody material placed in streambed to provide fish refuge. Note use of streambed gravel, mulch, and coir fabric*

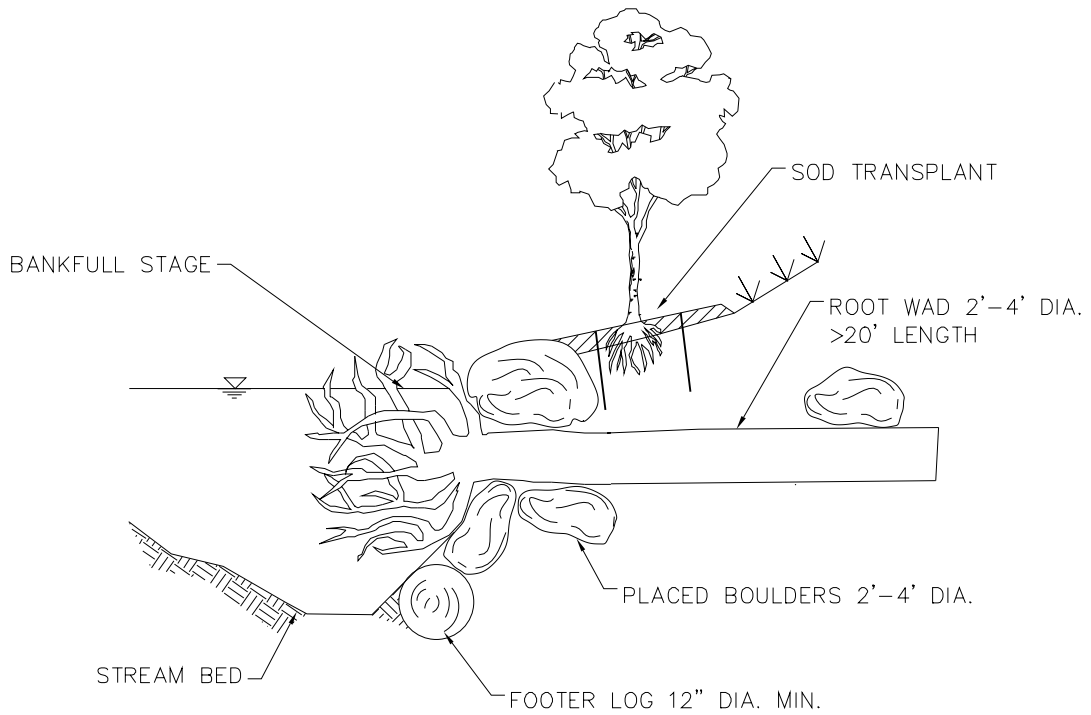

ROOT WAD: PLAN VIEW

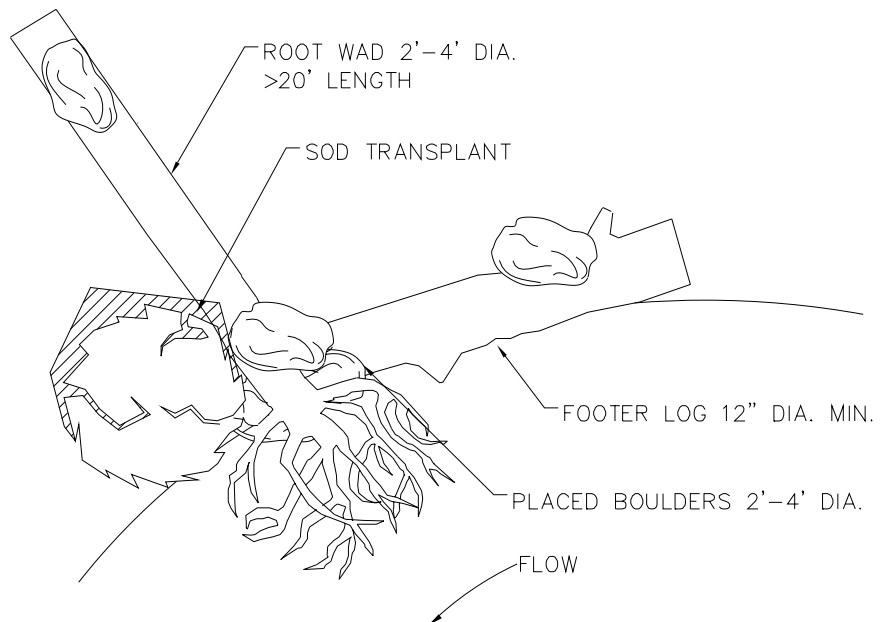



BMP: LARGE WOODY MATERIAL (continued)

TYPICAL CROSS SECTION – NATURAL MATERIAL REVETMENT

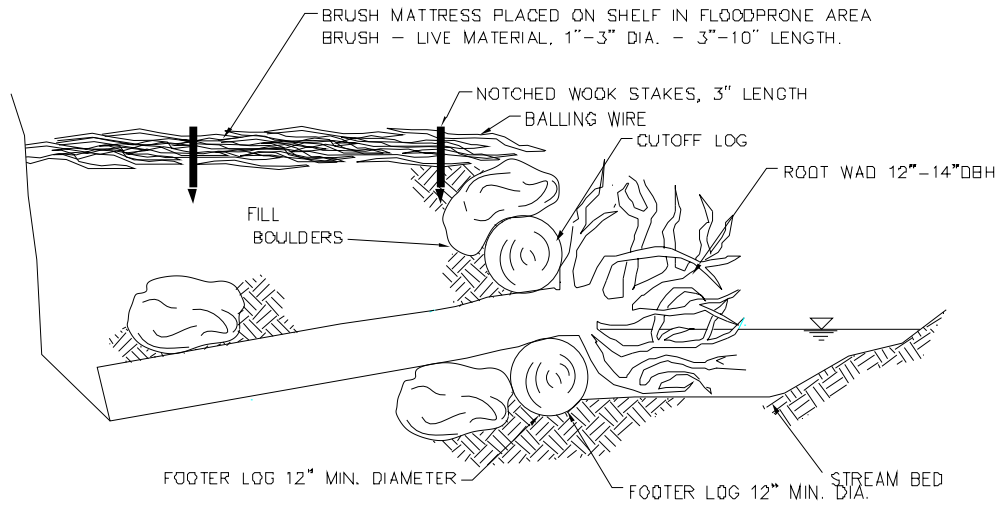

TYPICAL PLAN VIEW – NATURAL MATERIAL REVETMENT

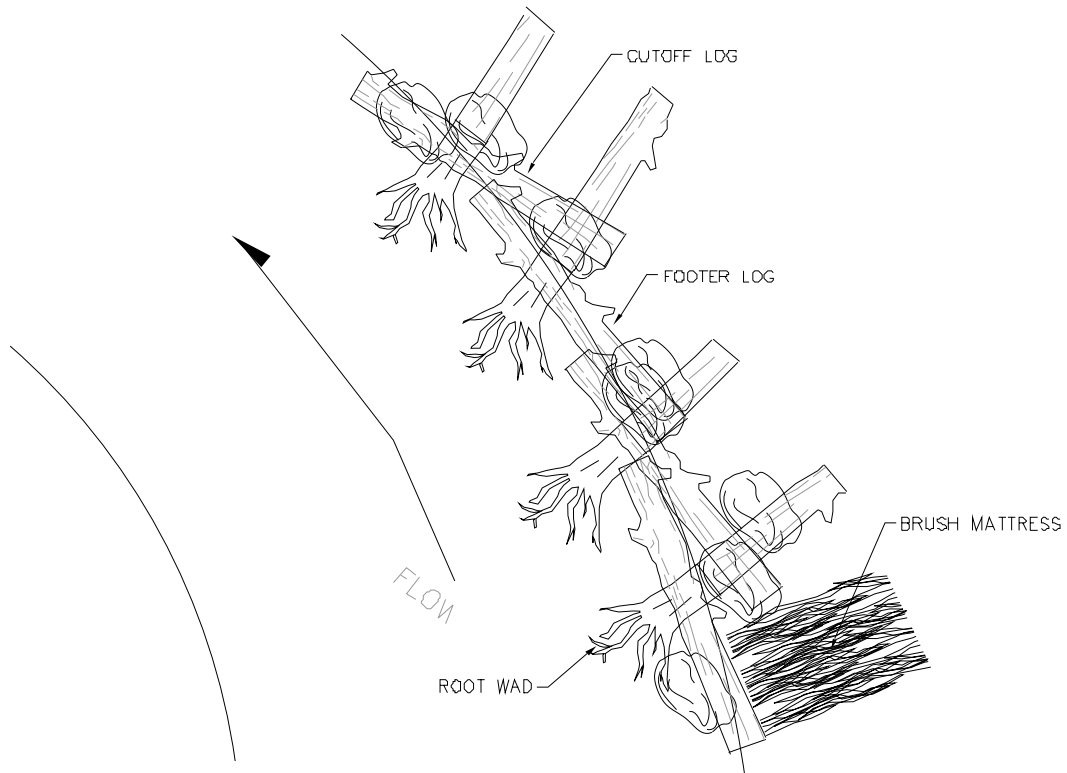



---

## DESCRIPTION

**L**ive stake planting involves the insertion of live, vegetative cuttings into the ground in a manner that allows the cutting (stake) to take root and grow. This BMP is used to reduce potential for soil becoming water borne, to reduce water velocity/erosive forces after vegetation establishment, and to aid in habitat protection/maintenance.

## PURPOSE

The purpose of this BMP includes, but is not limited to:

- Using a system of live stakes to create a root mat that stabilizes the soil by reinforcing and binding soil particles together.
- Using it in conjunction with other practices to provide for an increase in site stability.
- Providing habitat and shade when planted along stream and/or watercourse banks.
- Providing habitat for primary production.
- Providing habitat for prey base organisms such as macro-invertebrates.

## APPLICATIONS

This BMP may be used to repair small earth slips and slumps. It may be used to reinforce or enhance stream channel banks. Live staking may be used to anchor and enhance the effectiveness of willow wattles (fascines), excelsior filled logs, backslope planting, coir logs/fabric, or other erosion control material.

## LIMITATIONS

This BMP should not be used:

- Where vegetation growth will interfere with maintenance and/or facility access.
- Where vegetation growth will interfere with sight distance and/or create safety issues.
- For immediate soil stabilization results.



### **CONSTRUCTION GUIDELINES**

- Live staking must be done in accordance with design and/or permit conditions.
- Harvesting and planting should optimally occur during the dormant season (late fall to early spring).
- Use healthy live wood that is at least one year old.
- Make a clean angular cut at the butt end. Cutting should be a minimum of 24-inches long (for best results, use 36-inch long cutting) and up to 3" in diameter.
- For best results, prior to installation, soak cuttings in water for a minimum of 24 hours.
- Use a pilot bar (or similar device) in firm soils to establish a planting hole.
- Plantings should be inserted into the ground 2/3 the length of the stake. Re-cut any damaged or split ends after installation.
- Tamp soil around stake.

### **BMP MAINTENANCE**

- Periodic inspection, repair and maintenance will be done in accordance with permit requirements. If no permits are required, vegetation will be monitored until the vegetation is established.
- Staked area may need to be watered during summer months.

### **BMP REMOVAL**

- BMP removal is not necessary.





*Staked streambank to provide vegetative cover once vegetation has established*



*Using straw and live staking to reduce erosion and provide vegetative cover once vegetation has established*



This page intentionally left blank.

---





---

## DESCRIPTION

**M**ulching is the application of straw, wood chips, or other suitable materials on the soil surface applied manually or by machine. This BMP is used to reduce potential for soil becoming water borne or air borne and to reduce water velocity/erosive forces after vegetation establishment.

## PURPOSE

The purpose of this BMP includes, but is not limited to:

- Reducing erosion by protecting the soil surface from raindrop impact or wind.
- Decreasing surface water or wind velocity impacts.
- Fostering the growth of vegetation by increasing available moisture and providing insulation against extreme heat and cold.

## APPLICATIONS

This BMP can be used in areas to provide protection to the soil surface. Areas that have been seeded can be mulched to provide additional protection. This BMP may be used in combination with plantings of trees, shrubs, certain ground covers or in conjunction with seeding.

## LIMITATIONS

This BMP should not be used:

- On slopes steeper than 2 horizontal to 1 vertical.
- In watercourses and streams.
- In ditches where water flow is continuous.

## CONSTRUCTION GUIDELINES

- When used near watercourses or streams, this BMP must be used in accordance with permit requirements.
- Mulch should be applied so that the soil is covered sufficiently enough to allow seeds to germinate, but also protects the soil from erosion.
- Nets and matting may be used in combination with mulch.
- Various types and sizes of mulch are available.



## BMP: MULCHING (continued)

---

- If used to stabilize soil from wind forces, the mulch needs to be tilled or incorporated into the soil.

### **BMP MAINTENANCE**

- During construction, inspect BMPs daily during the workweek. Schedule additional inspections during storm events. Make any required repairs.
- Additional mulch should be applied where erosion or scouring occurs.
- If a tear occurs in the cover netting or matting, repair as necessary.

### **BMP REMOVAL**

- BMP removal is not necessary under normal circumstances.



*Using straw to reduce erosion in a slide area prior to a major stabilizing project*

# BMP

## PLASTIC COVERING



---

### DESCRIPTION

Plastic covering is used to cover exposed areas, which need immediate protection from erosion.

### PURPOSE

The purpose of this BMP includes, but is not limited to:

- Providing immediate temporary erosion protection to slopes, piles and disturbed areas that cannot be covered by mulching.
- Protecting exposed surfaces from water and/or wind erosion.
- Used in winter months as a temporary erosive control device when grass seed will not germinate.

### APPLICATIONS

This BMP may be used in disturbed areas, which require immediate erosion protection, areas seeded during winter and spring to aid in germination and for protection from heavy rain. Plastic covering may be used on steep slopes, construction sites and on stockpiles and/or excess materials. It may be used in combination with other BMPs.

### LIMITATIONS

This BMP should not be used:

- For long term erosion control.
- Without controlling surface water runoff from the plastic covered area.

### CONSTRUCTION GUIDELINES

- Plastic must be secured by staking or using weight (i.e. sandbag or tires) to prevent movement. Rebar must not be used as a staking mechanism.
- Plastic covering must be "keyed" in at the top of the slope.
- Additional BMPs, such as a berm and/or sediment control, must be used to control surface water runoff from plastic.

### BMP MAINTENANCE

- During construction, inspect BMPs daily during the workweek.



Schedule additional inspections during storm events. Make any required repairs.

- Replace damaged sections of plastic.

### **BMP REMOVAL**

- Evaluate site to determine BMP is no longer needed (the area has stabilized—potential of sediment laden water exiting the area has passed).
- Remove BMP (recycle and/or re-use if applicable).
- Re-vegetate area disturbed by BMP removal (if applicable).



*Plastic covering used as erosion protection on a slope at construction/repair area. Note additional use of mulch in area*



*Plastic covering used to protect exposed surface from erosion during construction/repair activities*



*Plastic covering used as a temporary erosion control on slope at slide area after storm and before repair*

# **BMP**

## **PLYWOOD WORK PLATFORM**



---

### **DESCRIPTION**

A plywood work platform is a temporary work area under bridges or piers consisting of framework, plywood, scaffolding and/or tarps. This BMP is used to reduce the potential for debris and contaminants falling into water.

### **PURPOSE**

The purpose of this BMP includes, but is not limited to:

- Providing a safe and efficient working environment.
- Containing fallen debris (concrete, wood chips, sawdust, slag and metal) from entering water during construction, maintenance and repair activities.

### **APPLICATIONS**

This BMP may be used under most small timber bridges, pipelines or piers. It may be used in combination with other BMPs.

### **LIMITATIONS**

This BMP should not be used:

- Where spans exceed 16 feet from bent to bent.

### **CONSTRUCTION GUIDELINES**

- Framework is usually 4 in. x 6 in. joists 16 inches on center which span the stream.
- 3/4 in. x 4 ft. x 8 ft. plywood is placed flat and tight, edge to edge, on joists, and tacked with 6 d nails for easy removal.
- Tarps are placed over the plywood deck and draped vertically approximately 36 in. high at the abutment wall of the deck and over the hand rails at the other edges.
- A truck mounted bridge work platform may be an option, depending on location and scope of work.
- A fire extinguisher shall be on hand at all times for spark and fire suppression.
- Ensure that plywood platform and tarp do not enter the water.





### **BMP MAINTENANCE**

- During construction, inspect BMPs daily during the workweek. Schedule additional inspections during storm events. Make any required repairs.
- Crew must provide frequent clean up of debris during the day.
- Rips or tears in the tarp must be repaired.

### **BMP REMOVAL**

- Evaluate site to determine BMP is no longer needed.
- Remove debris on BMP.
- Remove BMP (recycle and/or re-use if applicable).
- Re-vegetate bridge abutment area disturbed by maintenance activities (if applicable).



*Plywood work platform providing a safe work environment and containing fallen debris from entering water during construction, maintenance, and repair activities*



---

## **DESCRIPTION**

**R**ip rap is a long-term, erosion-resistant ground cover. It is composed of large, loose, angular rock which may be used to stabilize embankments and ditches. An optional filter fabric or granular underlining may be used.

## **PURPOSE**

This BMP includes, but is not limited to:

- Protecting the soil from the erosive forces of concentrated runoff.
- Reducing the velocity of runoff while enhancing the potential for infiltration.

## **APPLICATIONS**

This BMP may be used for stabilization of steep slopes with seepage problems and/or unstable soils that need armoring to prevent sloughing, downstream turbidity, and roadway or shoulder failure. This BMP should be used as a last resort in locations where planting or other stabilizing methods are impracticable. Rip rap may also be used to fill minor washouts along ditch lines, at culvert exits and entrances and shoulders. It may be used in combination with other BMPs.

## **LIMITATIONS**

This BMP should not be used in watercourses or streams:

- Without permit review and approval.
- When maintenance activities could reduce actual or potential high flow salmonid refuge functions, this BMP will only be used if:
  - Required or allowed by permit conditions.
  - Required by other regulations.

For applications outside of watercourses or streams, there are no limitations, other than design constraints.

## **CONSTRUCTION GUIDELINES**

- In locations where permits are required, rip rap must be placed in accordance with design and/or permit conditions.



## BMP: RIP RAP (continued)

---

- Remove unstable and unusable soil.
- Shape the sub-base to conform to site.
- Install fabric (if applicable).
- Place rip rap.

### **MAINTENANCE**

- Inspect periodically to determine if high flows have caused scour beneath the rip rap or filter fabric.

### **BMP REMOVAL**

- BMP removal may not be necessary. If BMP is removed, it should be done in accordance with design and applicable permits.



*Rip rap placed on slope for increased stability*



*Rip rap used to provide bank stability*

---



# BMP

## Rock Check Dam



---

### DESCRIPTION

A rock check dam is a small temporary or permanent dam constructed across a swale or drainage ditch. A rock check dam can be used to provide settling of soil particles and reduction in water velocity/erosive forces.

### PURPOSE

The purpose of this BMP includes, but is not limited to:

- Reducing water velocity/erosive forces.
- Trapping soil particles generated from adjacent areas or the drainage ditch.

### APPLICATIONS

Rock check dams may be used to aid in sediment trapping from a work site. It may be used in combination with other BMPs.

### LIMITATIONS

This BMP should not be used:

- When maintenance activities could reduce actual or potential high flow salmonid refuge functions, this BMP will only be used if:
  - Required or allowed by permit conditions.
  - Required by other regulations.
- When it affects fish passage.

For applications outside of watercourses or streams, there are no limitations, other than design constraints.

### CONSTRUCTION GUIDELINES

- In locations where rock check dams are required, rock check dam must be placed in accordance with design and/or permit conditions.

The maximum height of the dam shall be 3 feet.

- The center of the check dam must be at least 6 inches lower than the outer edges.
  - For added stability, the base of the check dam can be keyed into the soil approximately 6 inches.
  - Maximum spacing between the dams should be such that the toe of the
-



upgrade dam is at the same elevation as the top of the downgrade dam.

- Filter fabric may be used under the stone to provide a stable foundation and to facilitate the removal of the rock.
- Use in small open channels.
- Refer to sketches on following pages for details.

### **BMP MAINTENANCE**

- During construction, inspect BMPs daily during the workweek. Schedule additional inspections during storm events. Make any required repairs.
- Repair damaged BMPs due to end runs or undercutting.
- Sediment should be removed when deposits reach one-half the height of the BMP.
- Inspection on a regular basis should ensure that the center of the dam is lower than the edges. Erosion around the edges of the dam should be corrected.

### **BMP REMOVAL**

- Evaluate site to determine BMP is no longer needed (the area has stabilized—potential of sediment laden water exiting the area has passed).
- Remove sediment buildup in front of BMP



*Rock check dam in ditch to provide reduction in water velocity*



### ROCK CHECK DAM

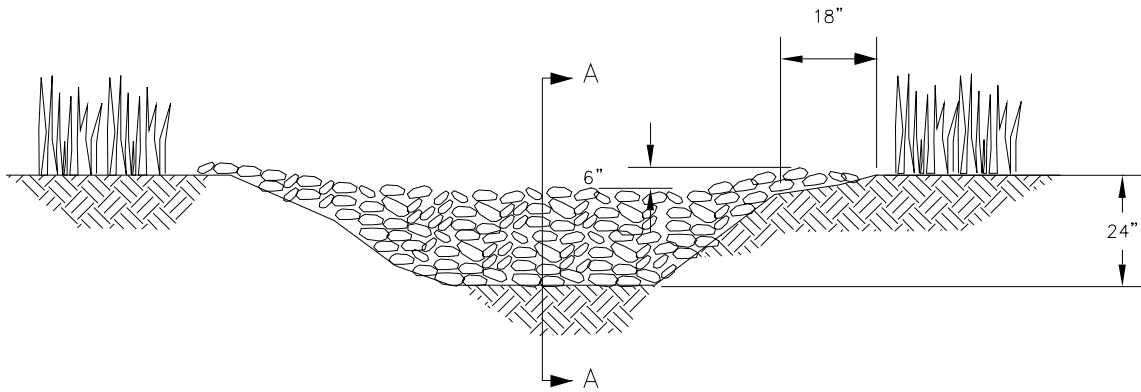

**NOTE**

KEY STONES INTO CHANNEL BANKS AND EXTEND IT BEYOND THE ABUTMENTS 18" (MIN.) TO PREVENT FLOW AROUND DAM.

### SPACING BETWEEN CHECK DAMS

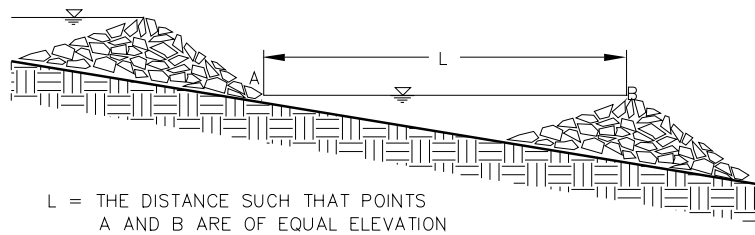

L = THE DISTANCE SUCH THAT POINTS A AND B ARE OF EQUAL ELEVATION

### SECTION A-A

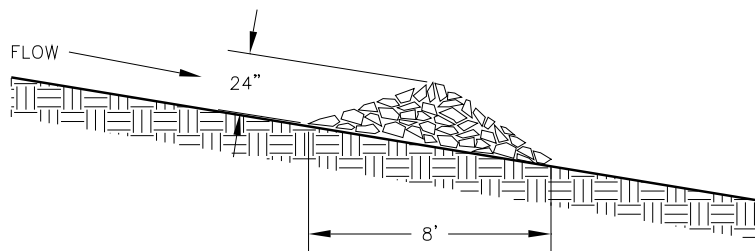

This page intentionally left blank.



---

## **DESCRIPTION**

A sandbag is a pre-manufactured cloth or plastic bag (polypropylene) filled with sand or gravel. Sandbags can be used to keep water from the work area, for settling and reduction in water velocity/erosive forces.

## **PURPOSE**

The purpose of this BMP includes, but is not limited to:

- A barrier.
- A protective barrier against flooding.
- Using in combination with other methods, to form a cofferdam.
- Using as a sediment filter (when used with clean pea gravel).
- Using as a ballast.
- Other multi-purpose situations.

## **APPLICATIONS**

Sandbags may be used during emergencies to build walls and control the flow and level of water. It may be used in combination with other barriers.

This BMP may be used during construction to form walls in dewatered areas, for example, cofferdams, and for various other impromptu situations.

## **LIMITATIONS**

This BMP should not be used:

- Where permit conditions state otherwise.
- When maintenance activities conducted in locations could reduce actual or potential high flow salmonid refuge functions, this BMP will be used if required by permit conditions.

## **CONSTRUCTION GUIDELINES**

- When used in watercourses or streams, this BMP must be used in accordance with permit requirements.
- Refer to Appendix E for Fish Exclusion Protocols.
- If sandbag filling is to be used as streambed gravel, it must be washed prior to filling bags, appropriately sized according to design and placed in accordance with permit conditions. Wash rock off-site (at a location where washed water can not enter watercourses, streams or wetlands) until water runs clear.
- Secure ends of sandbags to ensure material does not scatter.



- When used as a barrier, stack bags tightly together and in alternating, brick-layer fashion.

### **BMP MAINTENANCE**

- During construction, inspect BMPs daily during the workweek. Schedule additional inspections during storm events. Make any required repairs.
- Replace damaged sandbags.
- Repair damaged sandbag berm due to end runs or undercutting.
- Sediment should be removed when deposits reach one-half the height of the BMP.
- Check bags often for seepage and replace or add as needed.

### **BMP REMOVAL**

- Evaluate site to determine BMP is no longer needed (the area has stabilized—potential of sediment laden water exiting the area has passed).
- Remove sediment buildup in front of BMP.
- Remove BMP (recycle and/or re-use if applicable).
- Re-vegetate area disturbed by BMP removal (if applicable).
- Gravel filled bags may be split and the contents left in place, in streams, when so stated in the specific permit conditions (Bags are to be removed from job site).



*Sandbags acting as a barrier*



*A sandbag barrier used to decrease water velocity. Note use of silt mat and hydroseeding to decrease erosion and to increase vegetation in channel*



*Sandbags holding bypass pipe in place and detaining sediment laden water on site*





BMP: SANDBAG (continued)

---



*Sandbags filled with washed rock acting as a filter*



*Sandbags used in combination with plastic and strawbales serving as a barrier*



# **BMP SEDIMENTATION SUMP**



---

## **DESCRIPTION**

**S**edimentation sumps provide a sump within the flow line of ditches, swales, or channels to allow soil particles to collect and settle.

## **PURPOSE**

The purpose of this BMP includes, but is not limited to:

- Collecting soil particles by settlement.

## **APPLICATIONS**

This BMP may be used in areas where water quantity or velocities within steeper sloped ditches, swales, or channels are transporting sediment or material and impacting structures or habitat. It may be used in conjunction with other BMPs.

## **LIMITATIONS**

This BMP should not be used:

- To remove excessive fines.

## **CONSTRUCTION GUIDELINES**

- Place rim of structure at flow line elevation.
- Structures can be sized based on the quantity of soil particles and space availability within the transport facility.
- Structures can be placed with other BMPs such as ditch linings or grass lining.
- Structures can be placed in transport facilities where they collect sediment prior to pipe crossings into streams, wetlands, sensitive areas, or structures that easily plug with sediment.

## **BMP MAINTENANCE**

- Structures should be monitored after rainfall events for determination of cleaning schedule and frequency.
- Structures can be cleaned when necessary utilizing vector truck used in cleaning of catch basins.

## **BMP REMOVAL**

- BMP removal is not necessary.



## **BMP SILT FENCE**

### **DESCRIPTION**

A silt fence is a temporary sediment barrier consisting of fabric stretched across and attached to supporting posts and entrenched into the soil. It is generally installed perpendicular to the flow direction to slow or stop water and to allow filter/perimeter protection, settling of soil particles, and/or reduce water velocity/erosive forces.

### **PURPOSE**

The purpose of this BMP includes, but is not limited to:

- Intercepting sheet flow.
- Intercepting and detaining small amounts of water from disturbed areas during construction operations in order to allow for filtering or settling of soil particles.
- Decreasing down slope sheet flow velocity.
- Retain soil particles on site.

### **APPLICATIONS**

This BMP may be used for perimeter protection. It may be used in combination with other BMPs.

This BMP may be used below disturbed areas subject to sheet and rill erosion where drainage area is no greater than .25 acre per 100 lineal feet of barrier and the slope behind the barrier should be no steeper than 2 horizontal feet to 1 vertical foot. On relatively flat slopes, the maximum disturbed slope distance should not exceed 100 feet. The allowable disturbed slope distance decreases as the slope gets steeper.

### **LIMITATIONS**

This BMP should not be used:

- Where rock or hard surfaces prevent the full and uniform anchoring of the barrier.
- Directly in perennial streams or water courses.
- Around drop inlets.
- In front of storm drain inlets.
- As a diversion dam.

### **CONSTRUCTION GUIDELINES**

- The BMP should be placed along contours.



- The bottom of the fabric must be continuously and securely anchored for its entire length to reduce undermining.
- The height of the fence shall be adequate to reduce the potential of silt from leaving the job site.
- There must be at least a 3-foot overlap at vertical seams to avoid leakage. Both ends of the overlap must be securely attached to posts.
- Increase the elevation at the ends of the BMP installation to prevent "end runs."

### **BMP MAINTENANCE**

- During construction, inspect BMPs daily during the workweek. Schedule additional inspections during storm events. Make any required repairs.
- Replace damaged sections of fabric.
- Repair damaged BMPs due to end runs or undercutting.
- Sediment should be removed when deposits reach one-half the height of the BMP.

### **BMP REMOVAL**

- Evaluate site to determine BMP is no longer needed (the area has stabilized- potential of sediment laden water exiting the area has passed).
- Remove sediment buildup in front of BMP.
- Remove BMP (recycle and/or re-use if applicable).
- Re-vegetate area disturbed by BMP removal.



*Silt fence being installed on a temporary access road; used as perimeter protection*



BMP: SILT FENCE (continued)

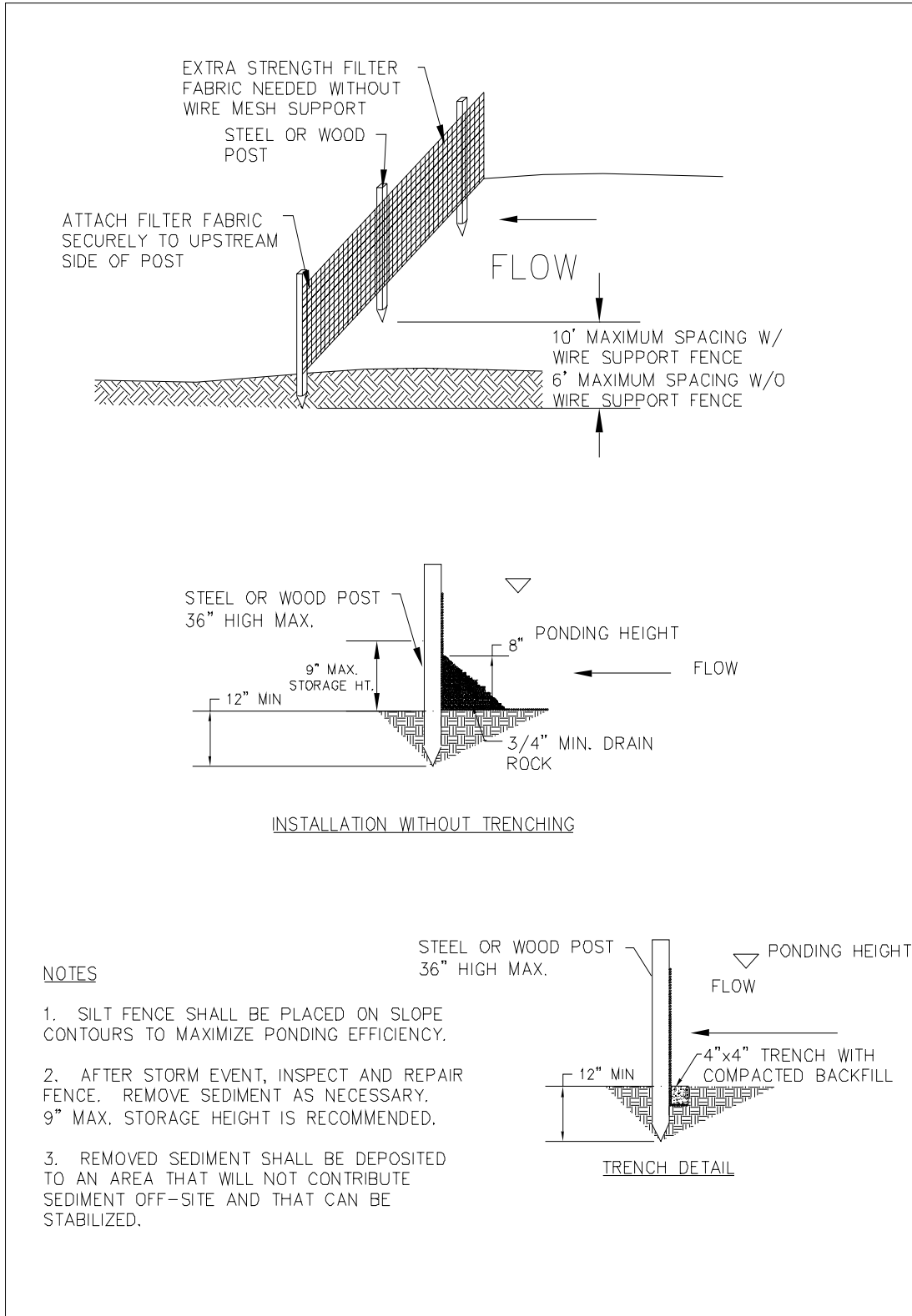



---

## **DESCRIPTION**

A silt mat is a flat pre-manufactured pad made in three layers: jute mesh, excelsior, and burlap. The pads are 4 feet by 10 feet and are biodegradable. Sediment passes through the mat layers and is held by the burlap layer. Silt mats can be used to provide filter/perimeter protection, settling and reduction in water velocity/erosive forces.

## **PURPOSE**

The purpose of this BMP includes, but is not limited to:

- Intercepting and detaining small amounts of soil particles.
- Preventing erosion at discharge points.

## **APPLICATIONS**

It may be used at pump discharges, pipe outlets, and/or downstream of work sites to retain soil particles and provide stabilization. It may also be used in ditch lines. It may be used in combination with other BMPs.

## **LIMITATIONS**

This BMP should not be used:

- As the only BMP when excessive soil particles are present.
- In high flow rates.

## **CONSTRUCTION GUIDELINES**

- This BMP may be used singly or in a group on the streambed immediately downstream of a work site.
- Silt mats should be installed with either staples or stakes.
- There is no need for disposal. Place on adjacent slope or leave in place after use and add seed and mulch to stabilize the slope.
- Joints need to be overlapped according to flow.

## **BMP MAINTENANCE**

- During construction, inspect BMPs daily during the workweek. Schedule additional inspections during storm events. Make any required repairs.



## BMP: SILT MAT (continued)

---

- Sediment loads should be monitored frequently to ensure the silt mat's capacity load is not exceeded. Replace silt mats before capacity is reached. (Unless used in conjunction with re-vegetation).
- Check periodically for gaps.

### **BMP REMOVAL**

- Evaluate site to determine BMP is no longer needed (the area has stabilized—potential of sediment laden water exiting the area has passed).
- Remove BMP (recycle and/or re-use if applicable).
- Silt mat may be incorporated into permanent stabilization/re-vegetation process.
- Re-vegetate area disturbed by BMP removal (if applicable).



*Silt mat installed in ditch to decrease erosion and allow settlement of suspended solids*

# BMP

## SILTATION POND/SETTLING TANK



---

### DESCRIPTION

A siltation pond/settling tank is a temporary containment structure or area for silt laden water to be initially discharged. After sufficient settling, the water may be discharged to sanitary sewer, storm drainage system or other BMP.

### PURPOSE

The purpose of this BMP includes, but is not limited to:

- Allowing soil particles to settle prior to water being discharged off-site.
- Settling water borne soil particles on site.
- Controlling the flow of water through a settling tank may require a control structure such as a tee fitting, an oil/water separator or an orifice.

### APPLICATIONS

This BMP may be used wherever silt laden water must be removed from a construction site. It may be used in combination with other BMPs.

### LIMITATIONS

This BMP (Siltation Pond) should not be used:

- In soils that are not compatible for filtration, unless a liner is used.
- If there is inadequate space to process the volume of sediment-laden water.

### CONSTRUCTION GUIDELINES

- Silt ponds must be installed according to applicable permit requirements.
- Water discharged from siltation pond/settling tank shall meet permit requirements at the point of discharge.
- If an existing Retention/Detention facility or Settling Pond is near by, it may be utilized.
- Check site to determine if there is adequate space for pond excavation.
- Portable tanks may be used where ponds can not be constructed.
- Siltation pond should be designed according to surface water design standards.



- Stabilize pipe outlet to minimize scour and erosion.
- An optional liner may be used in ponds where soils are incompatible with filtration

### **BMP MAINTENANCE**

- During construction, inspect BMPs daily during the workweek. Schedule additional inspections during storm events. Make any required repairs.
- Inspect filtering or control devices frequently. Repair or replace them to ensure that the structure functions as designed.

### **BMP REMOVAL**

- Evaluate site to determine pond/tank is no longer needed (the area has stabilized—potential of sediment laden water exiting the area has passed).
  - Follow engineer's recommendations for removal of BMP.
  - Recycle excess construction materials if feasible.
  - When siltation pond is removed it shall be in such a manner as to minimize disturbance. Remaining sediment shall be removed and/or disposed of according to permit conditions.
- Re-vegetate area disturbed by BMP removal according to permit (if applicable).



*Large silt pond with turbidity curtain in place*





*A settling tank in use to allow onsite containment of water borne soil particles*



*Settling tank*



## **BMP SOIL STABILIZATION (BLANKETS AND MATTING)**

---

### **DESCRIPTION**

Soil stabilization can be accomplished through the installation of a protective blanket (covering) or a soil stabilization mat on a prepared planting area, a steep slope, channel and/or shoreline.

### **PURPOSE**

The purpose of this BMP includes, but is not limited to:

- Reducing erosion.
- Providing a microclimate that protects young vegetation and promotes its establishment.
- "Reinforcing the turf" to resist the forces of erosion during storm events.

### **APPLICATIONS**

This BMP may be used on short, steep slopes where erosion hazard is high and planting is likely to be slow in establishment. It may also be used on stream banks or tidal shorelines where moving water is likely to wash out new plantings. Soil stabilization blankets and matting may be used in combination with other BMPs.

### **LIMITATIONS**

This BMP should not be used:

- In watercourses or streams without proper permits.

### **CONSTRUCTION GUIDELINES**

- Installation is site specific.
- See following drawings and specifications.

### **BMP MAINTENANCE**

- If vegetation is incorporated, inspect during the plant establishment period. Re-plant, due to mortality, as necessary.
- Schedule additional inspections during storm events. Check for erosion or undermining; any required repairs shall be made.

### **BMP REMOVAL**

- BMP removal is not necessary.
-



*Stabilizing the soil in a sensitive area using blankets*



*Lining a ditch with soil stabilization matting to reduce erosion*



*Stabilizing the soil using matting and hydroseeding*



BMP: SOIL STABILIZATION (BLANKETS AND MATTING) (continued)

TYPICAL TREATMENT  
SOIL STABILIZATION MATTING INSTALLATION

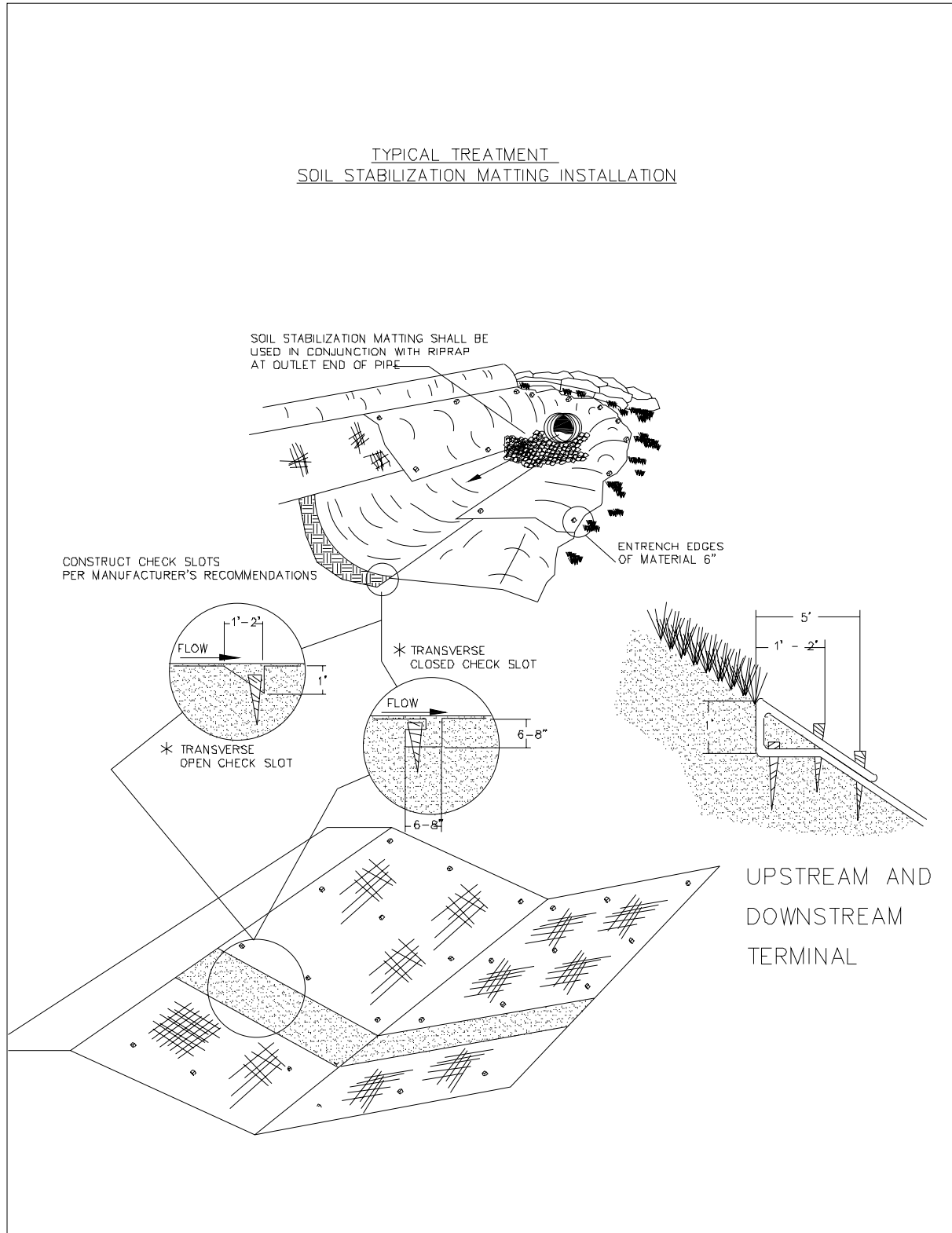



TYPICAL TREATMENT  
SOIL STABILIZATION MATTING SLOPE INSTALLATION

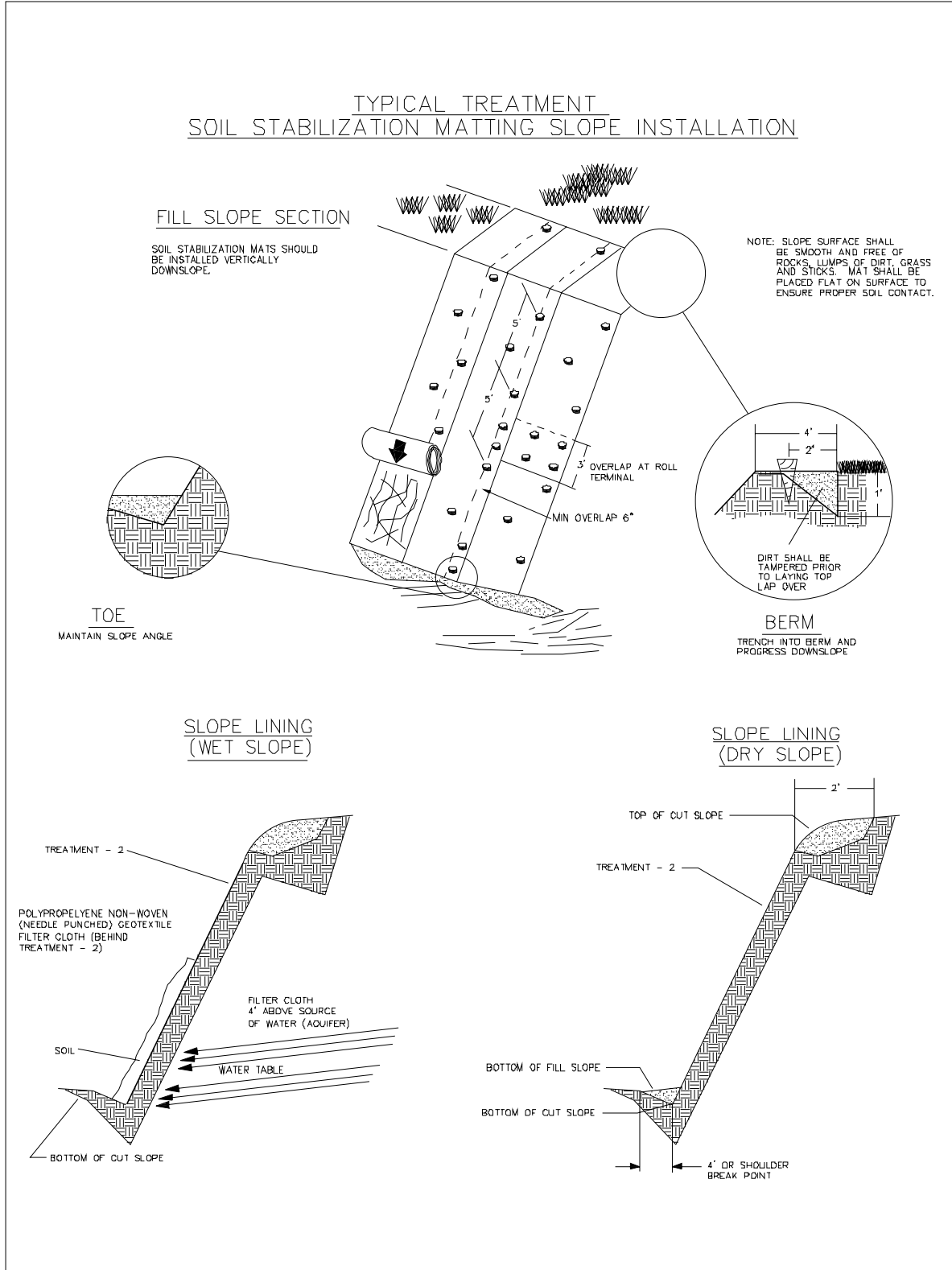



BMP: SOIL STABILIZATION (BLANKETS AND MATTING) (continued)

GENERAL STAPLE PATTERN GUIDE AND RECOMMENDATIONS AND  
(SOIL STABILIZATION MATTING)

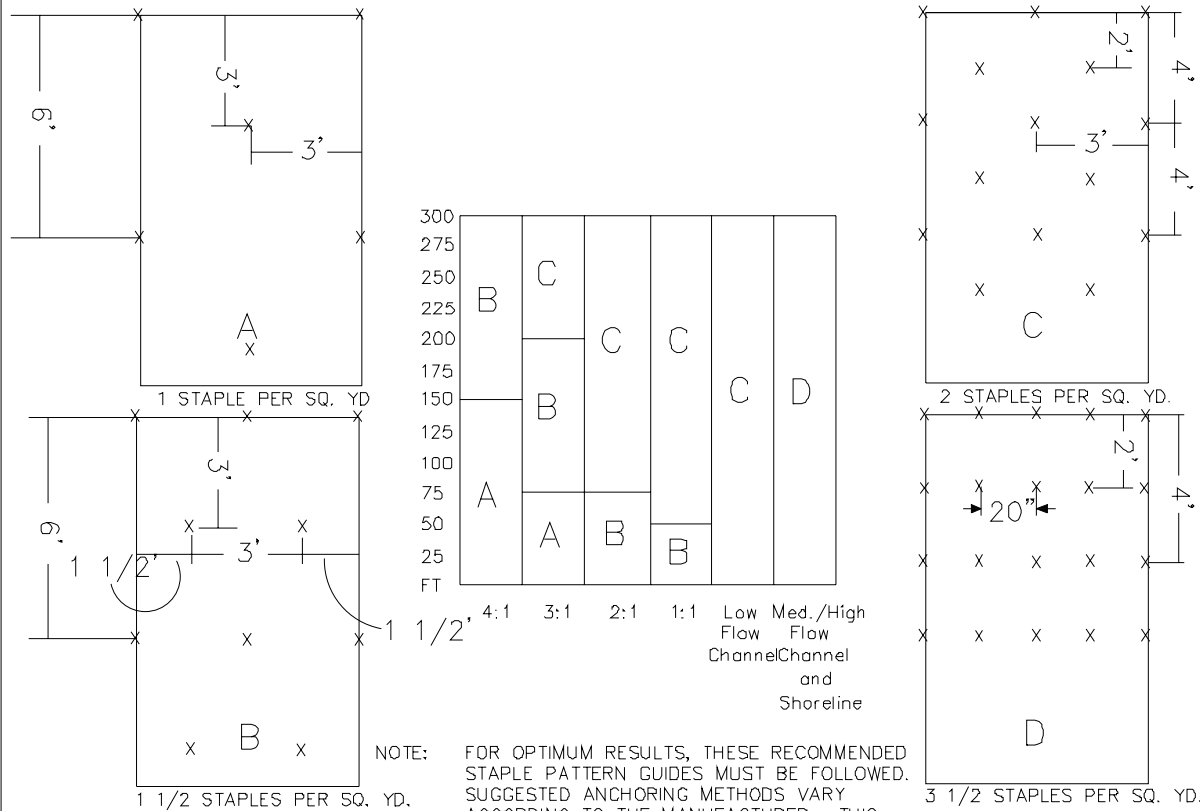

NOTE: FOR OPTIMUM RESULTS, THESE RECOMMENDED STAPLE PATTERN GUIDES MUST BE FOLLOWED. SUGGESTED ANCHORING METHODS VARY ACCORDING TO THE MANUFACTURER. THIS CHART SHOWS HOW TO SLOPE LENGTHS AND HOW GRADIENTS AFFECT STAPLING PATTERNS.

# BMP

## STRAW BALE BARRIER (1)



---

### DESCRIPTION

A strawbale barrier (1) is a small temporary barrier constructed across a non-fish bearing swale, gully, or drainageway. It is generally installed perpendicular to the flow direction to slow or stop water and to allow filter/perimeter protection, settling of soil particles, and/or reduce water velocity/erosive forces.

### PURPOSE

The purpose of this BMP includes, but is not limited to:

- Intercepting sheet flow.
- Intercepting and detaining small amounts of soil particles from disturbed areas during construction operations in order to allow settling of soil particles.
- Decreasing down slope sheet flow velocity.
- Retaining soil particles on site.

### APPLICATIONS

This BMP may be used in areas where permanent stabilization cannot be accomplished immediately. It may be used in combination with other BMPs.

### LIMITATIONS

This BMP should not be used:

- Where rock or hard surfaces prevent the full and uniform anchoring of the barrier.
- When maintenance activities could reduce actual or potential high flow salmonid refuge functions, this BMP will only be used if:
  - Required or allowed by permit conditions.
  - Required by other regulations.
- Where flow volume or water velocity inhibit BMP function.

### CONSTRUCTION GUIDELINES

- Place bales in a single row perpendicular to the flow, with ends tightly abutting one another.



- The bottoms of the end bales should be placed higher in elevation than the top of the middle bale spillway to ensure sediment-laden runoff will flow over the barrier, and not around it.
- Bales shall be installed so that bindings are oriented around the sides rather than on the tops and bottoms, to prevent deterioration.
- Bales shall be entrenched a minimum of 4 inches.
- Gaps between bales shall be sealed by wedging straw in the space to limit escaping water.
- Bales shall be securely anchored by at least two stakes driven into the ground a minimum depth of 18 inches.
- See following pages for construction guidelines and additional detail.

#### **BMP MAINTENANCE**

- During construction, inspect BMPs daily during the workweek. Schedule additional inspections during storm events.
- Any required repairs shall be made. (Repair any damaged BMPs due to end runs or undercutting).
- Sediment should be removed when deposits reach one-half the height of the BMP.

#### **BMP REMOVAL**

- Evaluate site to determine BMP is no longer needed (the area has stabilized—potential of sediment laden water exiting the area has passed).
- Remove sediment buildup in front of BMP.
- Remove BMP.
- Re-vegetate area disturbed by BMP removal.





### PROPERLY INSTALLED STRAW BALE BARRIER (CROSS SECTION)

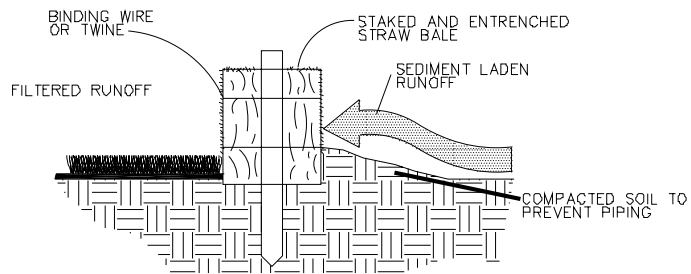

### CONSTRUCTION OF STRAW BALE BARRIER

1. EXCAVATE THE TRENCH

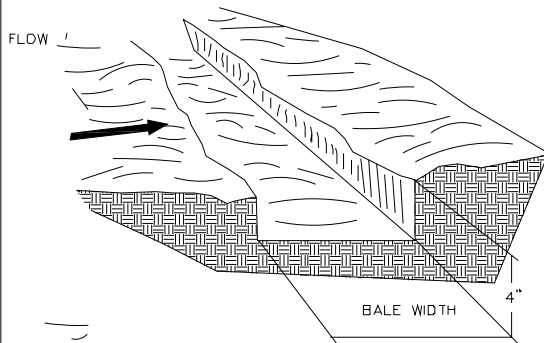

2. PLACE AND STAKE STRAW BALES

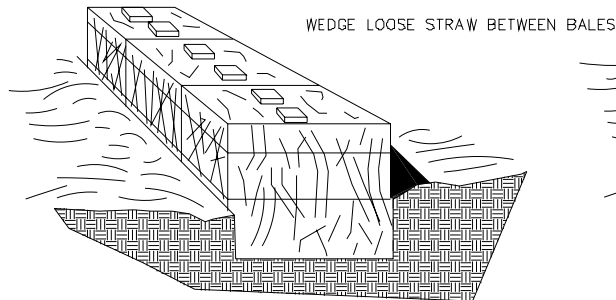
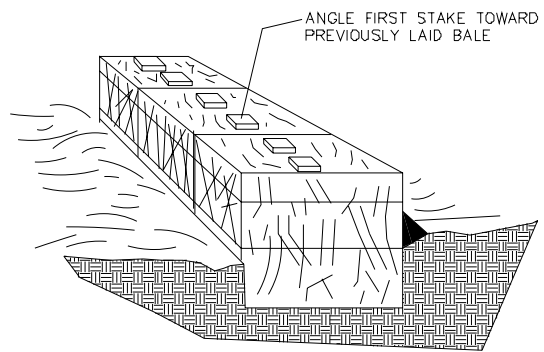

3. WEDGE LOOSE STRAW BETWEEN BALES

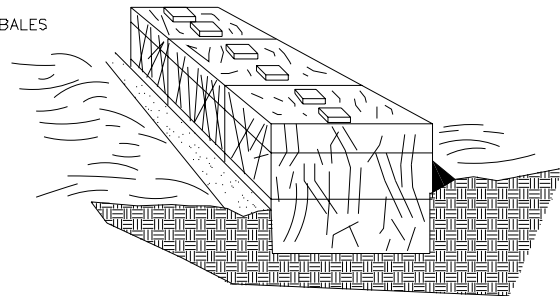

4. BACKFILL AND COMPACT THE EXCAVATED SOIL



## **BMP**

### **STRAW BALE BARRIER (2)**

---

#### **DESCRIPTION**

A straw bale barrier (2) is a temporary sediment barrier consisting of a row of entrenched and anchored straw bales. It is generally installed perpendicular to the flow direction to slow or stop water and to allow filter/perimeter protection, settling of soil particles, and/or reduce water velocity/erosive forces.

#### **PURPOSE**

The purpose of this BMP includes, but is not limited to:

- Intercepting sheet flow.
- Intercepting and detaining small amounts of water from disturbed areas during construction operations in order to allow settling of soil particles.
- Decreasing down slope sheet flow velocity.
- Retaining sediment on site.

#### **APPLICATIONS**

This BMP may be used for perimeter sediment control. It may be used in combination with other barriers.

This BMP may be used below disturbed areas subject to sheet and rill erosion where drainage area is no greater than .25 acre per 100 lineal feet of barrier and the slope behind the barrier should be no steeper than 2 horizontal to 1 vertical. On relatively flat slopes the maximum disturbed slope distance should not exceed 100 feet. The allowable disturbed slope distance decreases as the slope gets steeper.

#### **LIMITATIONS**

This BMP should not be used:

- Where rock or hard surfaces prevent the full and uniform anchoring of the barrier.
  - Directly in watercourses or streams when fish are present.
  - When maintenance activities could reduce actual or potential high flow salmonid refuge functions, this BMP will only be used if:
    - Required or allowed by permit conditions.
-



- Required by other regulations.
- Where flow volume or water velocity inhibit BMP function.

## **CONSTRUCTION GUIDELINES**

- Bales shall be placed in a single row, lengthwise on the contour, with ends of adjacent bales tightly abutting one another. (If area does not allow a single row, additional rows need to be installed in a staggered fashion).
- Bales shall be installed so that bindings are oriented around the sides rather than on the tops and bottoms, to prevent deterioration.
- Bales shall be entrenched a minimum of 4 inches.
- Bales shall be securely anchored by at least two stakes driven into the ground a minimum depth of 18 inches.
- Gaps between bales shall be sealed by wedging straw in the space to limit escaping water.
- Loose straw scattered over the area immediately uphill from the bale may increase barrier efficiency.
- See following pages for construction guidelines and additional detail.

## **BMP MAINTENANCE**

- During construction, inspect BMPs daily during the workweek. Schedule additional inspections during storm events.
- Any required repairs shall be made. (Repair any damaged BMPs due to end runs or undercutting).
- Sediment should be removed when deposits reach one-half the height of the BMP.

## **BMP REMOVAL**

- Evaluate site to determine BMP is no longer needed (the area has stabilized—potential of sediment laden water exiting the area has passed).
- Remove sediment buildup in front of BMP.
- Remove BMP (recycle and/or re-use if applicable).
- Re-vegetate area disturbed by BMP removal.



BMP: STRAW BALE BARRIER (2) (continued)

---



*Straw Bale Barrier (2) reducing water velocity and erosive forces. Note other BMPs also being used*



## STRAW BALE CHECK DAM

PLAN

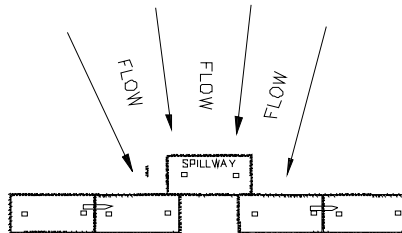

VIEW LOOKING UPSTREAM

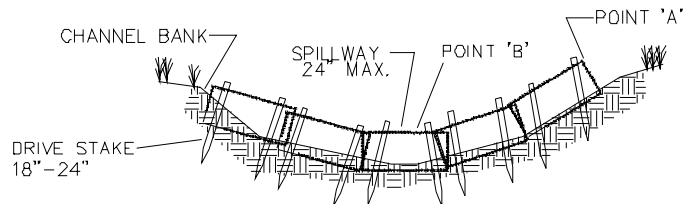

SECTION A - A  
SPACING BETWEEN CHECK DAMS

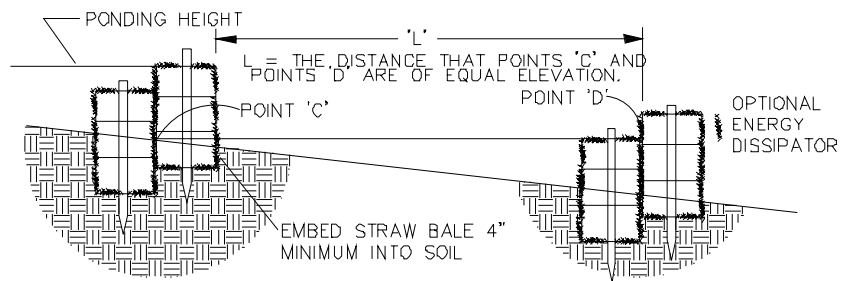

NOTES:

1. EMBED BALES 4" INTO THE SOIL AND 'KEY' BALES INTO THE CHANNEL BANKS.
2. POINT 'A' MUST BE HIGHER THAN POINT 'B' (SPILLWAY HEIGHT).
3. PLACE BALES PERPENDICULAR TO THE FLOW WITH ENDS TIGHTLY ABUTTING
4. SPILLWAY HEIGHT SHALL NOT EXCEED 24".



BMP: STRAW BALE BARRIER (2) (continued)

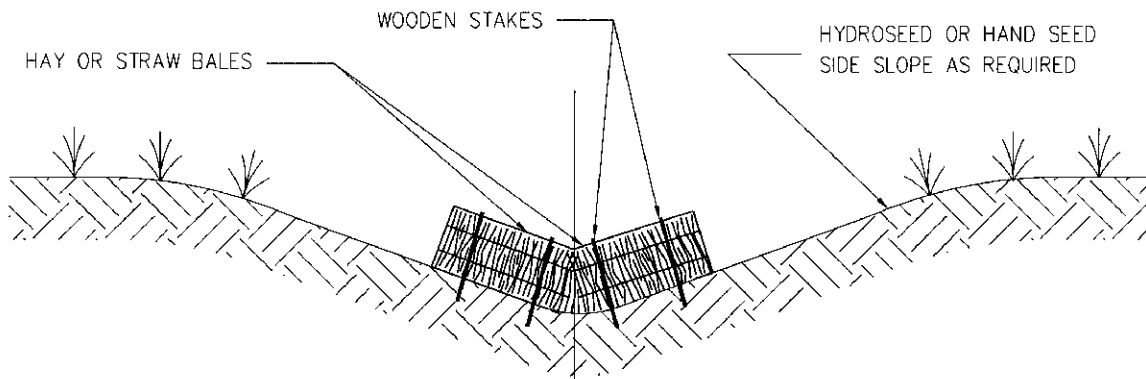
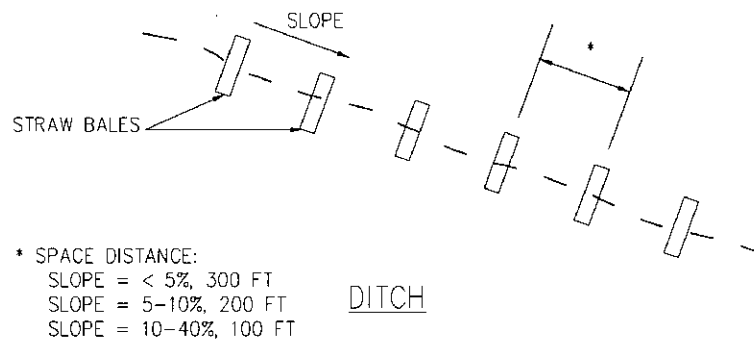
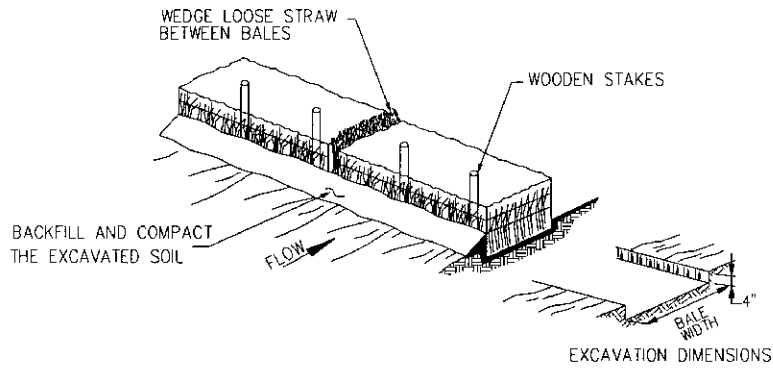

STRAW BALE BARRIER

N.T.S.

## **BMP**

# **STRAW BALE BARRIER (3)**



---

### **DESCRIPTION**

A straw barrier (3) is a temporary barrier consisting of straw bales and a rock spillway placed across small drainage areas or gently sloping swales. It is generally installed perpendicular to the flow direction to slow or stop water and to allow filter/perimeter protection, settling of soil particles, and/or reduce water velocity/erosive forces.

### **PURPOSE**

The purpose of this BMP includes, but is not limited to:

- Intercepting sheet flow.
- Intercepting and detaining small amounts of water from disturbed areas during construction operations in order to allow settling of soil particles.
- Allowing runoff to flow through or over the barrier.
- Decreasing runoff velocity.
- Retaining sediment on site.

### **APPLICATIONS**

This BMP may be used in small channel flow situations. The rock size used in the spillway can be enlarged to accommodate larger flows.

### **LIMITATIONS**

This BMP should not be used:

- Where rock or hard surfaces prevent the full and uniform anchoring of the barrier.
- Directly in watercourses or streams when fish are present.
- When maintenance activities could reduce actual or potential high flow salmonid refuge functions, this BMP will only be used if:
  - Required or allowed by permit conditions.
  - Required by other regulations.
  - Where flow volume or water velocity inhibit BMP function.

### **CONSTRUCTION GUIDELINES**

- Maximum height of the spillway shall be 2 feet.





- See following pages for construction guidelines and additional detail.
- Bales shall be installed so that bindings are oriented around the sides rather than on the tops and bottoms, to prevent deterioration.
- Bales shall be entrenched a minimum of 4-inches.
- Bales shall be securely anchored by at least two stakes driven into the ground a minimum depth of 18 inches.

### **BMP MAINTENANCE**

- Inspect bales periodically and after each significant rainfall.
- Sediment shall be removed when it reaches one-half the height of the bale.

### **BMP REMOVAL**

- Evaluate site to determine BMP is no longer needed (the area has stabilized—potential of sediment laden water exiting the area has passed).
- Remove sediment buildup in front of BMP.
- Remove BMP (recycle and/or re-use if applicable).
- Re-vegetate area disturbed by BMP removal.



*Straw Bale Barrier (3) being used with a rock spillway decreasing runoff velocity and retaining sediment onsite*

---





## SEMI-PERVIOUS STRAW BALE SEDIMENT BARRIER

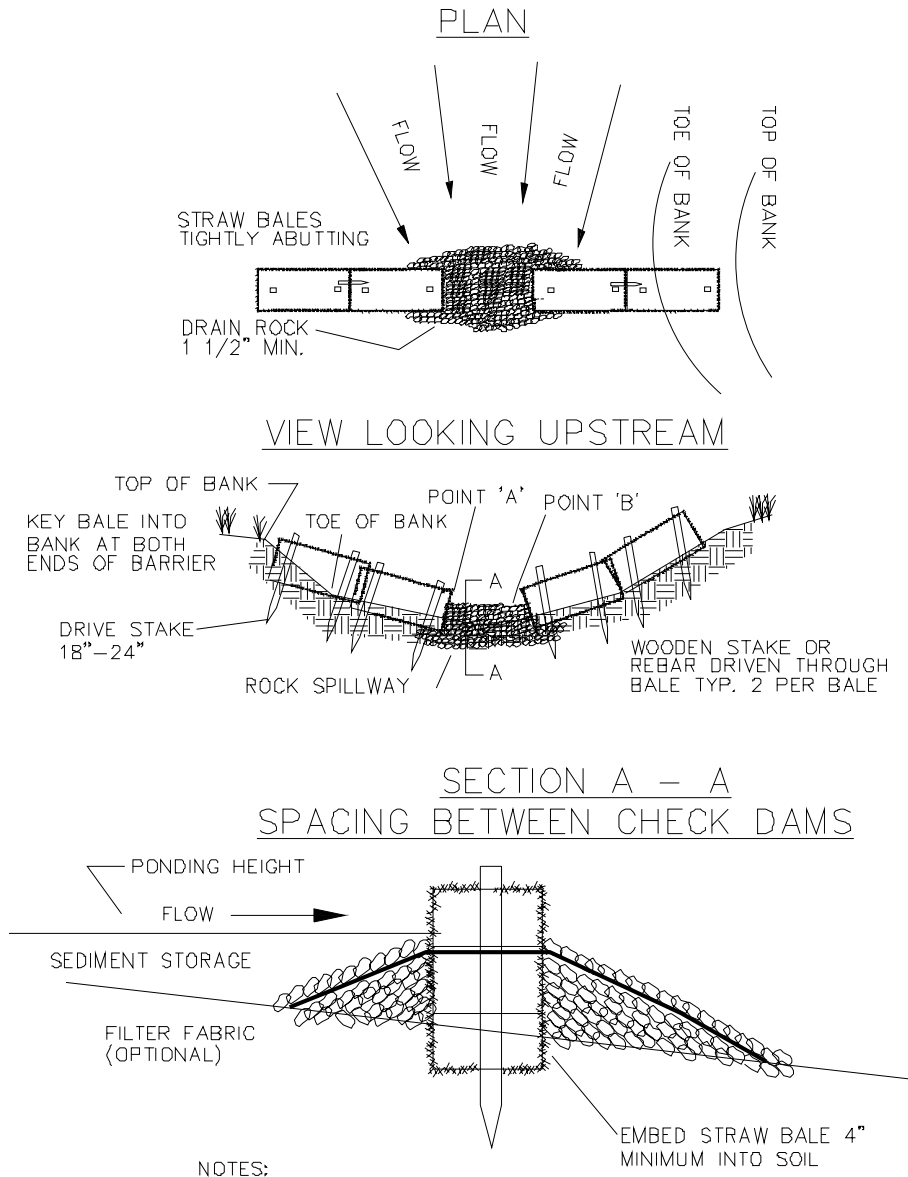

**NOTES:**

1. EMBED BALES 4" INTO THE SOIL AND 'KEY' BALES INTO THE CHANNEL BANKS. PREVENT FLOW AROUND BALES.
2. POINT 'A' MUST BE HIGHER THAN POINT 'B' (SPILLWAY HEIGHT).
3. PLACE BALES PERPENDICULAR TO THE FLOW WITH ENDS TIGHTLY ABUTTING
4. SPILLWAY HEIGHT SHALL NOT EXCEED 24".



## **BMP STRAW LOG**

---

### **DESCRIPTION**

**S**traw logs are manufactured from straw (or flax) wrapped in plastic netting. Logs are placed and staked along the contour of newly constructed or disturbed slopes, in shallow trenches. When cut or folded to appropriate length, these logs can be used to provide filter/perimeter protection, settling, reduction in water velocity/erosive forces.

### **PURPOSE**

The purpose of this BMP includes, but is not limited to:

- Reducing slope length to capture and retain sediment on the slope.
- Temporarily stabilizing slopes by reducing soil creep, sheet and rill erosion until permanent vegetation can be established.
- Trapping topsoil and retaining moisture from rainfall, which aids in growth of seedlings planted along the upslope side of the rolls.
- Intercepting and detaining small amounts of water from disturbed areas during construction operations in order to promote settling of soil particles.
- Filtering soil particles and debris.
- Reducing water velocity and erosive forces.

### **APPLICATIONS**

This BMP may be used in ditches or across culvert ends of any dimension. It may be used instead of excelsior filled logs, coir logs, or straw bale filtering systems. Straw logs may also be used for perimeter sediment control. This BMP is particularly useful in areas where the effects of soil disturbance need to be minimized.

This BMP may be used in gullies and stream channels as check dams; in conjunction with gabions, rip rap, articulated block, or cellular confinement systems. It may be used to anchor and enhance the effectiveness of willow wattles (fascines), turf reinforcement mats, coir mats, continuous berms and other erosion control material. Straw logs may be used to replace silt fences or straw bales on steep slopes. It may be used in combination with other BMPs.



---

## LIMITATIONS

This BMP should not be used:

- Where flow volume or water velocity inhibit BMP function.
- For permanent applications. (Other than vegetation).
- When maintenance activities could reduce actual or potential high flow salmonid refuge functions, this BMP will only be used if:
  - Required or allowed by permit conditions.
  - Required by other regulations.

## CONSTRUCTION GUIDELINES

- Logs are placed and staked along the contour of newly constructed or disturbed slopes, in 2-3 inch deep trench.
- Spacing depends on soil type and slope steepness.
- Tightly abut any adjacent logs.
- Install to prevent water from going around or under BMP.
- See "Live Staking", "Handseeding" and/or "Hydroseeding" BMP for planting.

## BMP MAINTENANCE

- During construction, inspect BMPs daily during the workweek. Schedule additional inspections during storm events. Make any required repairs.
- Sediment should be removed when deposits reach one-half the height of the BMP.

## BMP REMOVAL

- Evaluate site to determine BMP is no longer needed (the area has stabilized—potential of sediment laden water exiting the area has passed).
- Remove sediment buildup in front of BMP.
- Depending upon BMP placement, re-vegetation of site may be necessary.
- BMP removal may not be necessary.



BMP: STRAW LOG (continued)

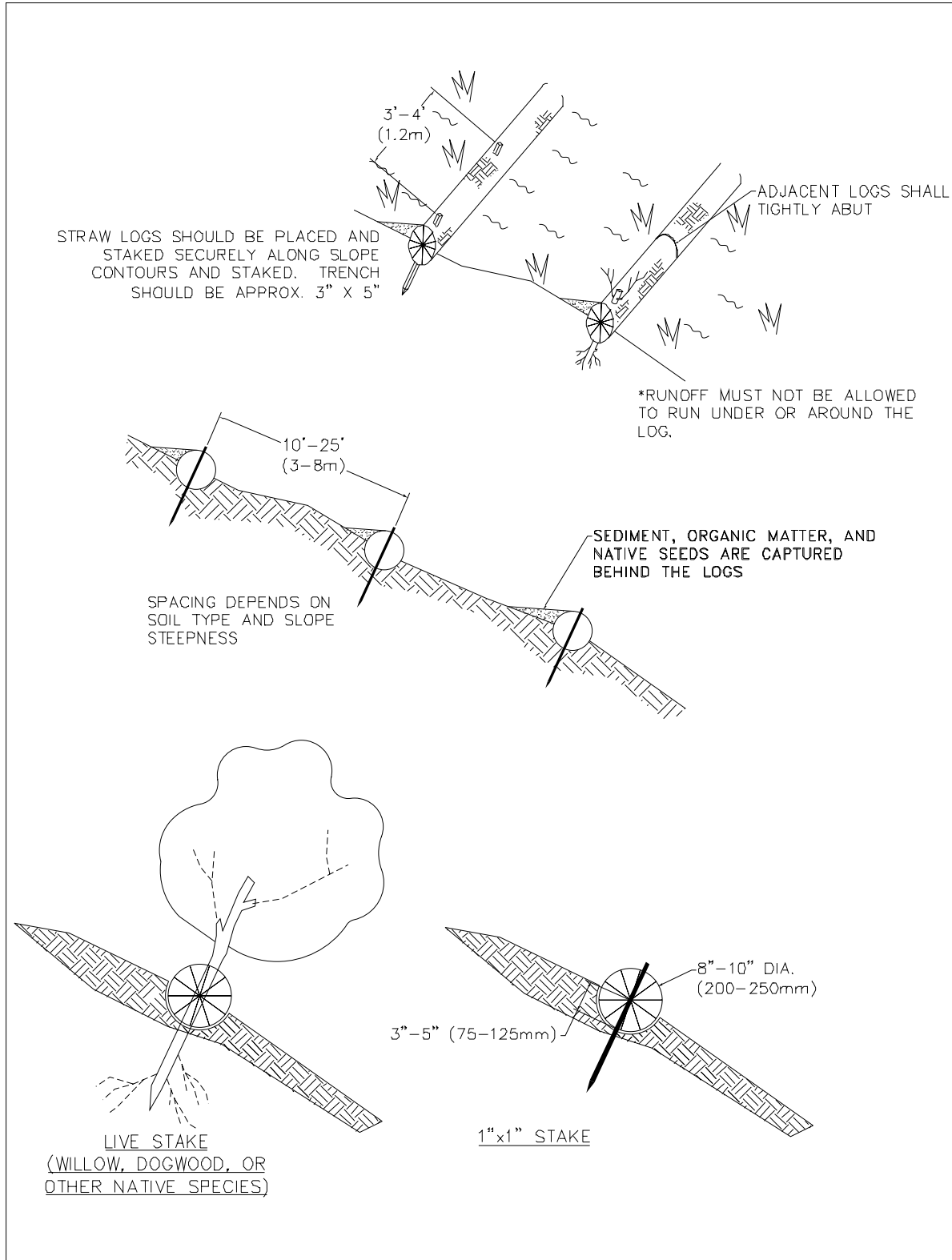

# BMP

## STREAM BANK STABILIZATION (BIO-ENGINEERING)



### DESCRIPTION

This BMP utilizes vegetation as a method of stabilizing stream banks. Use of stream bank stabilization requires design. Use of this BMP will be determined through the permit process for maintenance work, however, this would normally be done as a Capital Improvement Project(CIP).

### PURPOSE

The purpose of this BMP includes, but is not limited to:

- Protecting stream banks from the erosive forces of flowing water, thereby, reducing silts and sedimentation.
- Using it in conjunction with other practices to provide for an increase in site stability.
- Providing habitat and shade when planted along stream and/or watercourse banks.
- Providing habitat for primary production.
- Providing habitat for prey base organisms such as macro-invertebrates.



*Stabilizing the stream bank by using coir logs, hydroseeding, and live staking.  
Streambed gravel installed to provide a natural spawning substrate*



## **BMP STREAM BYPASS**

---

### **DESCRIPTION**

A stream bypass is a method of diverting the main flow of a stream to a temporary alternate route during construction. It is used in conjunction with a cofferdam and pumps. A stream bypass may be constructed by various methods or combination of methods such as earthen berms, sand bags, ecology blocks and aqua barriers.

### **PURPOSE**

The purpose of this BMP includes, but is not limited to:

- Diverting flowing water away from or around a construction site.
- Minimizing sedimentation.
- In limited cases, it may provide for fish passage.

### **APPLICATIONS**

This BMP may be used at stream crossings during culvert replacement, at bridge repair sites, and other sites where the stream flow cannot be interrupted. It may be used in combination with other barriers.

### **CONSTRUCTION GUIDELINES**

- Stream bypass BMPs must be installed according to applicable permit requirements.
- Refer to Appendix E for Fish Exclusion Protocols.
- Determine best method for specific site.
- Discuss strategy with crew.
- Work quickly to avoid water contamination by sediment.
- Stabilize pipe outlet to minimize scour and erosion.
- Pump and bypass should be designed or reviewed by an engineer to ensure capacity can handle peak flows.
- Ensure that stream bypasses do not entrain salmonids at pipes and pumps.

### **BMP MAINTENANCE**

- Inspect bypass, pump, and dam periodically. Repair any leaks.
  - Check for scour at bypass outfall. Repair or move as necessary.
-



## BMP: STREAM BYPASS (continued)

---

- Have adequate fuel supply and backup pumps in the event of mechanical failure.
- Inspect fish isolation nets to ensure complete exclusion. Remove any accumulated debris from isolation net.

### **BMP REMOVAL**

- Remove BMP when in-water work is complete.
- Remove BMP (recycle and/or re-use if applicable).
- Re-vegetate area disturbed by BMP removal (if applicable).



*A stream bypass used to divert water around a construction site*





BMP: STREAM BYPASS (continued)

---



*A stream bypass used to divert water around a construction site*





### STREAM BYPASS DETAILS

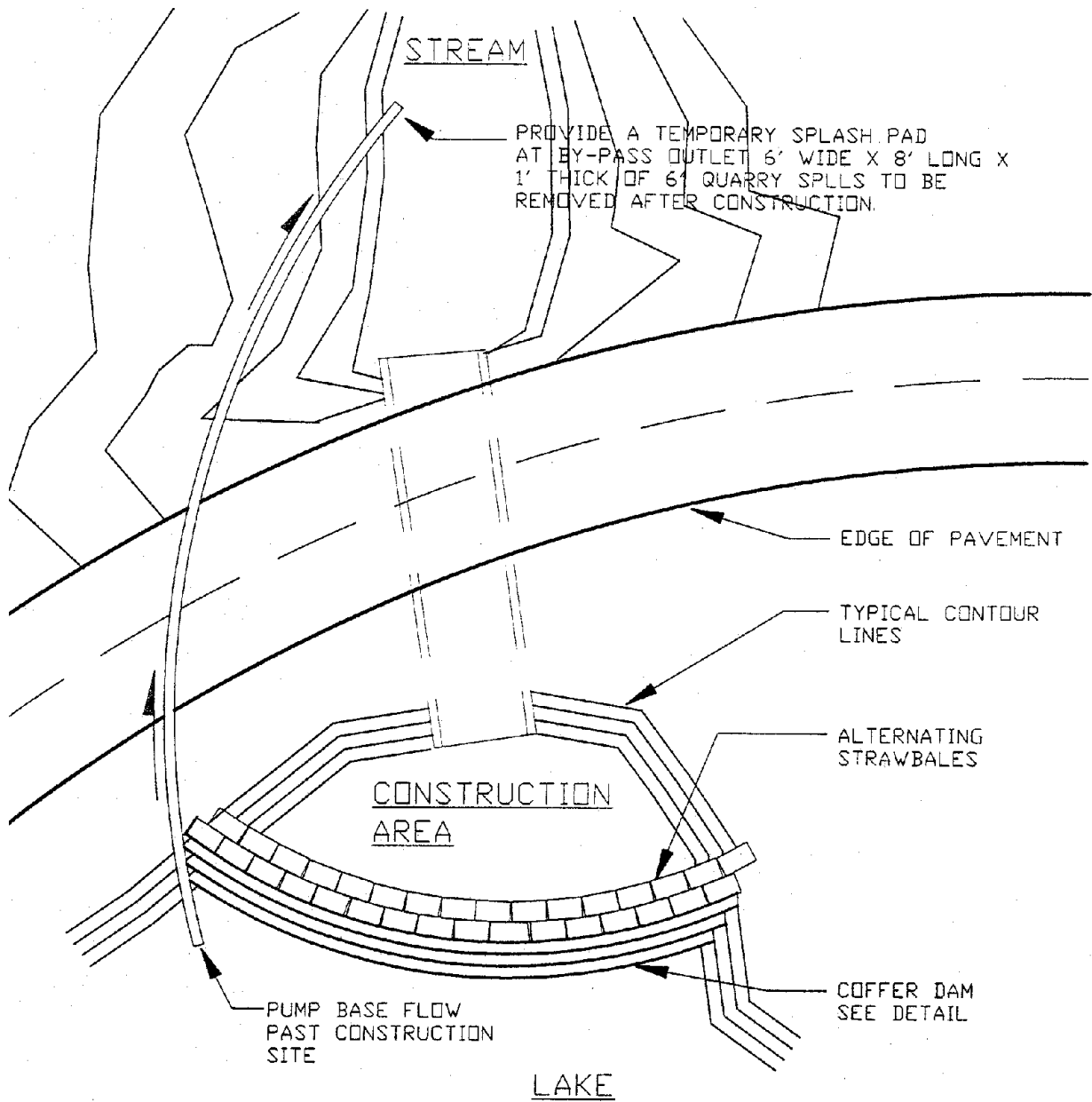



## **BMP** **STREAMBED GRAVEL**

---

### **DESCRIPTION**

**S**treambed gravel is, non-angular gravel of variable sizes used for habitat protection/maintenance, bridge maintenance or culvert replacements (which may be watercourses or streams).

### **PURPOSE**

The purpose of this BMP includes, but is not limited to:

- Providing a natural substrate.
- Minimizing siltation in ditches and/or stormwater facilities.

### **APPLICATIONS**

This BMP may be used to provide fish habitat in sensitive areas, culverts or ditches used by fish. It may be used in combination with other BMPs.

### **LIMITATIONS**

This BMP should not be used:

- If the gravel does not meet design specifications.

### **CONSTRUCTION GUIDELINES**

- Streambed gravel must be placed in accordance with applicable design and/or permit conditions.
- Check gravel gradation to ensure it meets design specifications.
- If gravel does not meet specifications because of excessive fines, wash rock off-site (at a location where washed water can not enter watercourses, streams or wetlands) until water runs clear.
- Haul material in clean truck bed.
- Dump streambed gravel onto tarped area on-site.
- Place a cover or berm around streambed gravel stockpiles.

### **BMP MAINTENANCE**

- Inspect piles of streambed gravel periodically.

### **BMP REMOVAL**

- BMP removal is not applicable.



*Placing streambed gravel inside a newly installed cross culvert to provide a natural substrate for fish*



## **BMP** **SURFACE ROUGHENING**

---

### **DESCRIPTION**

**S**urface roughening is roughening a bare, sloped soil surface with horizontal grooves running across the slope. Grooves can be large-scale, such as grooving with disks, tiller, or other machinery, or with heavy track machinery which should be reserved for sandy, noncompressible soils. Roughening aids the establishment of vegetative cover, improves water infiltration, and decreases runoff velocity. This BMP is intended to keep soil from becoming water borne and reduces water velocity/erosive forces.

### **PURPOSE**

The purpose of this BMP includes, but is not limited to:

- Reducing runoff velocity and increasing infiltration.
- Reducing erosion and providing for sediment trapping.
- Aiding in establishment of vegetative cover with seed.
- Reducing wind velocity at the soil surface.

### **APPLICATIONS**

This BMP should be used as a temporary technique. It may be used in areas to reduce surface runoff or wind velocity until other BMPs can be installed. This BMP may be used on steeper slopes where revegetation is establishing. This BMP may be used in combination with other BMPs.

### **LIMITATIONS**

This BMP should not be used:

- On slopes with a rock surface.
- On excessively roughened slopes where mowing is planned.
- In sensitive areas with hydric soils, due to heavy compaction.
- On steep slopes without simultaneous revegetation.

### **CONSTRUCTION GUIDELINES**

- Surface roughening shall be done by operating tracked equipment up and down the slope to leave traverse depressions in the soil.
- As few passes as possible should be made to minimize soil compaction.



## BMP: SURFACE ROUGHENING (continued)

---

- The surface should be roughened to a depth of 2 to 4 inches.

### **BMP MAINTENANCE**

- During construction, inspect BMPs daily during the workweek. Schedule additional inspections during storm events. Check for erosion, scour and sloughing, make any required repairs.

### **BMP REMOVAL**

- BMP removal is not applicable.



BMP: SURFACE ROUGHENING (continued)

SURFACE ROUGHENIN

TRACKING

TRACKING WITH MACHINERY  
UP AND DOWN THE SLOPE  
PROVIDES GROOVES THAT  
WILL CATCH SEED  
RAINFALL AND REDUCE  
RUNOFF

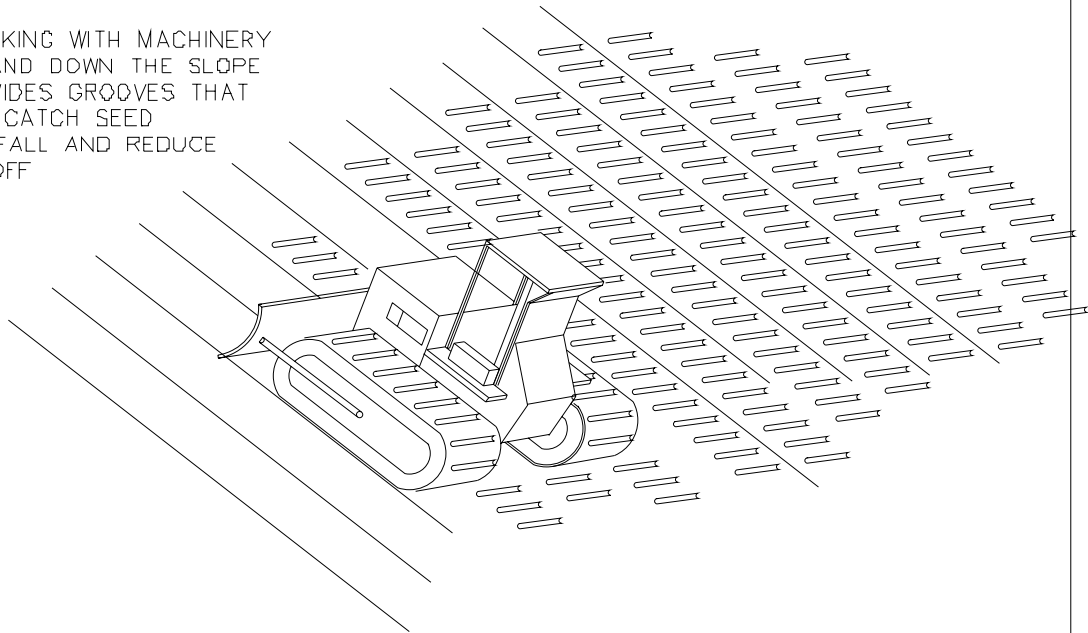

CONTOUR FURROWS

GROOVES WILL CATCH  
SEED, FERTILIZER,  
MULCH, RAINFALL, AND  
DECREASE RUNOFF.

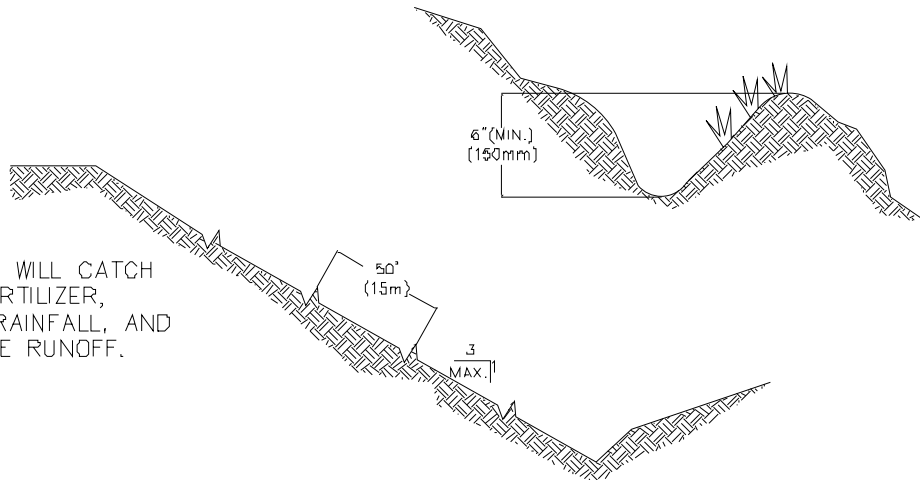



TRACKING

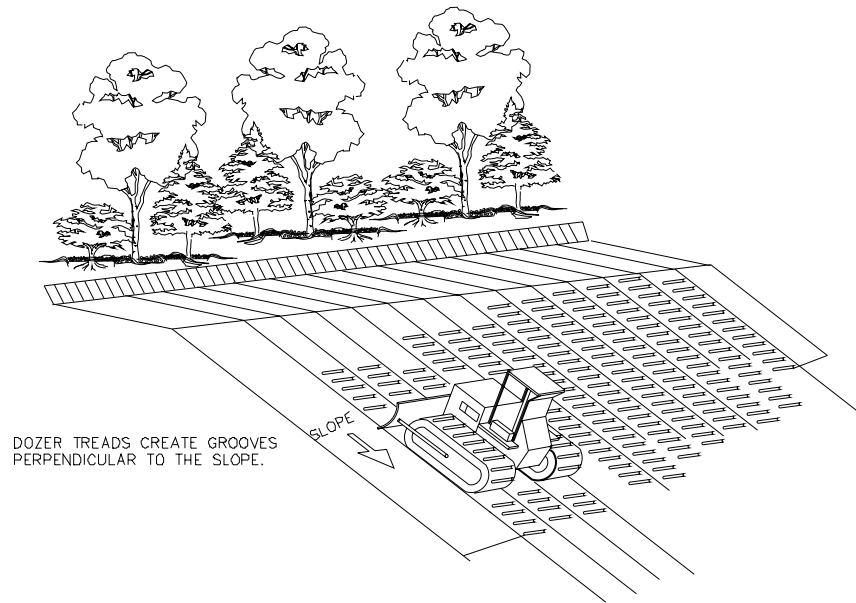

FILL SLOPE TREATMENT

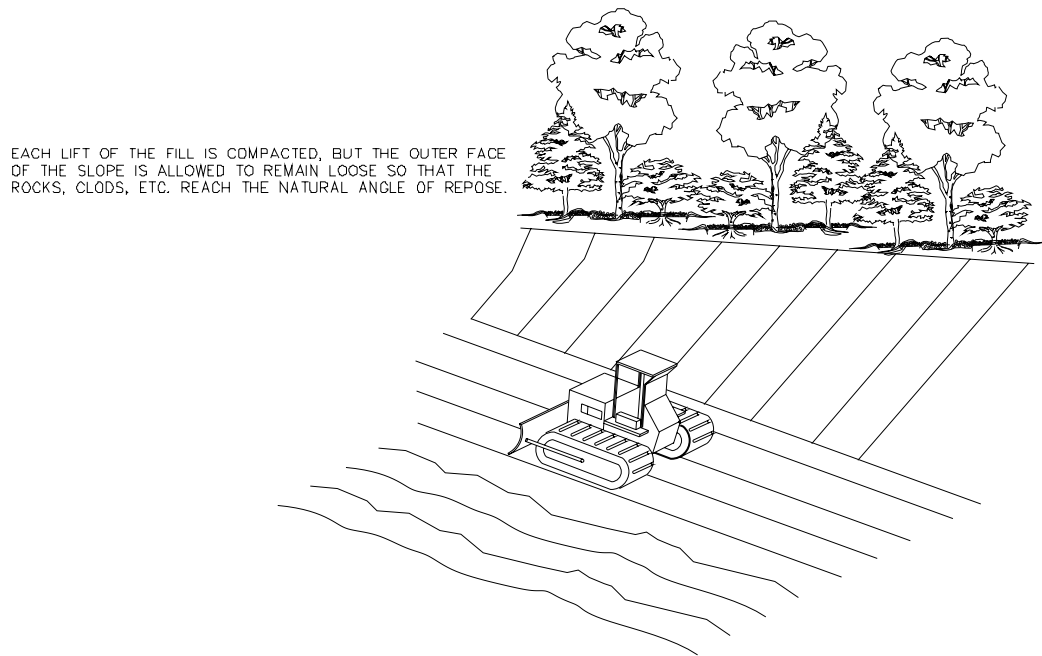



## **BMP SWEEPING**

---

### **DESCRIPTION**

**S**weeping is done by hand or mechanical means. A sweeper is a vehicle with brushes and/or a vacuum system and a water spray system used on the roadways to remove debris and soil particles.

### **PURPOSE**

The purpose of this BMP includes, but is not limited to:

- Removing soil particles and debris before entering drainage systems, streams or watercourses.
- Suppressing dust on roadways and at construction sites.
- Removal of snow sand after snow and ice control operations.

### **APPLICATIONS**

This BMP may be used to remove soil particles, debris and/or snow sand from paved surfaces. It may be used in combination with other BMPs.

### **LIMITATIONS**

- All street sweeping is a benefit. There are no limitations.

### **CONSTRUCTION GUIDELINES**

- Use pickup brooms in sensitive areas.
- Use water with mechanical brooms.
- Schedule snow sand removal as part of the snow and ice emergency response.
- Dispose of collected material.

### **BMP MAINTENANCE**

- BMP maintenance is not applicable.

### **BMP REMOVAL**

- BMP removal is not applicable.





*A sweeper picking up debris and soil particles on a paved access road*

This page intentionally left blank.

# **BMP**

## **TEMPORARY SEDIMENT TRAP**



---

### **DESCRIPTION**

A temporary sediment trap is a small ponding area formed by constructing an earthen embankment with a rock outlet to allow for soil particle settling.

### **PURPOSE**

The purpose of this BMP includes, but is not limited to:

- Intercepting and detaining small amounts of water from disturbed areas during construction operations in order to allow settling of soil particles.
- Retaining sediment on site.

### **APPLICATIONS**

This BMP may be used below disturbed areas where the total contributing drainage area is less than 3 acres. Drainage areas larger than 3 acres may use other BMPs such as siltation ponds or settling tanks, as defined in applicable permit conditions. It may also be used where the sediment trap will be used no longer than 18 months. This BMP may be used in combination with other BMPs.

### **LIMITATIONS**

This BMP should not be used:

- In areas where the total contributing drainage area is more than 3 acres.

### **CONSTRUCTION GUIDELINES**

- The area under the embankment shall be cleared and stripped of any vegetation and root mat.
- Fill material shall be free of roots or other woody vegetation, organic material and other unsuitable material.
- All embankment slopes shall be not steeper than 2 horizontal to 1 vertical.
- The embankment shall be seeded.

### **BMP MAINTENANCE**

- During construction, inspect BMPs daily during the workweek.



BMP: TEMPORARY SEDIMENT TRAP (continued)

---

Schedule additional inspections during storm events. Make any required repairs.

- Sediment shall be removed when it has accumulated to one-half the original dimension.

**BMP REMOVAL**

- Evaluate site to determine BMP is no longer needed (the area has stabilized—potential of sediment laden water exiting the area has passed).
- Remove sediment buildup from BMP.
- Remove BMP (recycle and/or re-use if applicable).
- Re-vegetate area disturbed by BMP removal (if applicable).



BMP: TEMPORARY SEDIMENT TRAP (continued)

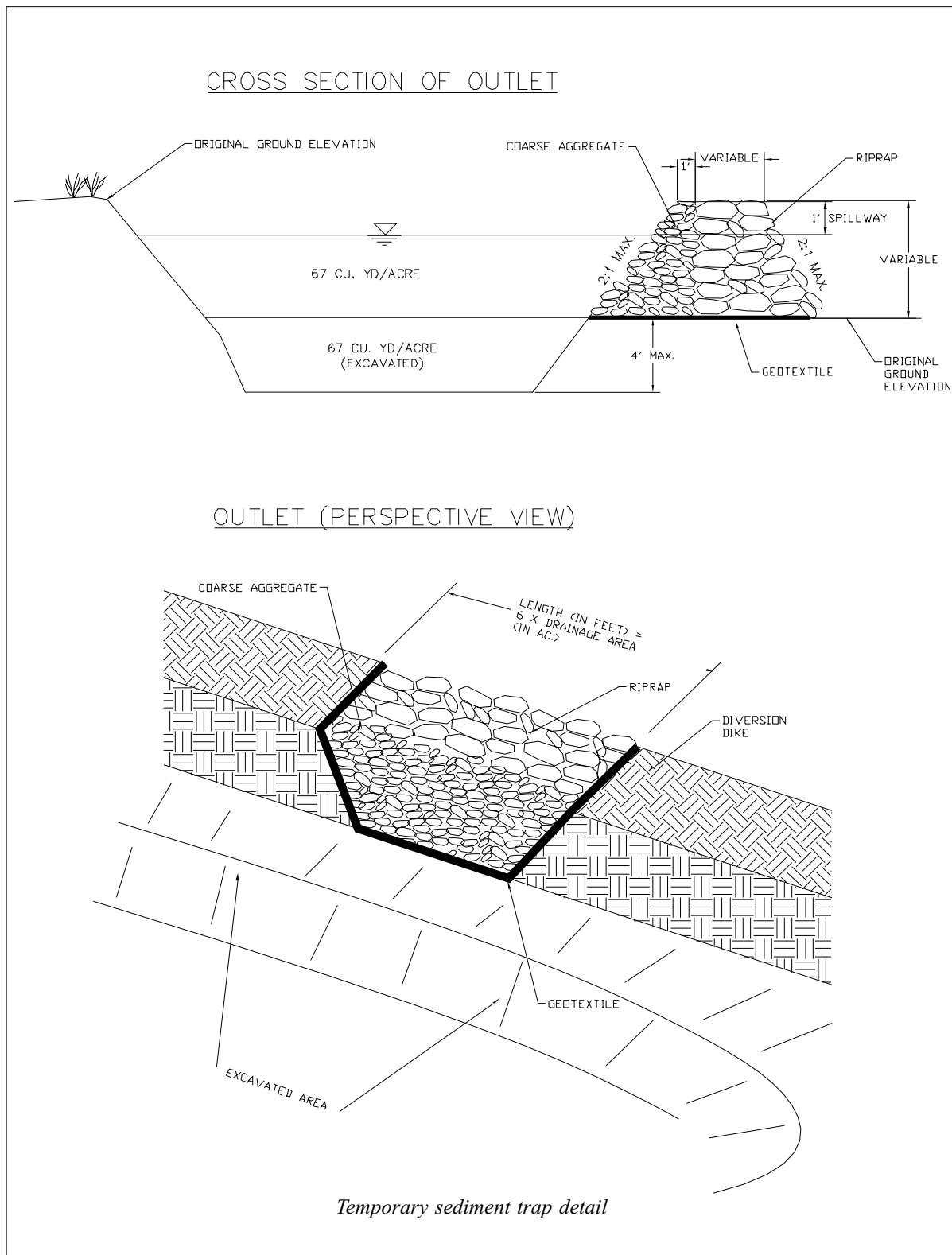



## **BMP**

### **TRIANGULAR SILT DIKE**

---

#### **DESCRIPTION**

A triangular silt dike is a sediment control device made of foam sewn into a woven geo-synthetic fabric. It is triangular in shape, 10 in. to 14 in. high in the center, with a 20 in. to 28 in. base. An apron extends beyond both sides of the triangle along its standard section of 7 ft. A sleeve at one end allows attachment of additional sections as needed. This BMP can be used to provide settling and/or reduction in water velocity/erosive forces.

#### **PURPOSE**

The purpose of this BMP includes, but is not limited to:

- Intercepting sheet flow.
- Intercepting and detaining small amounts of water from disturbed areas during construction operations in order to allow settling of soil particles.
- Decreasing down slope sheet flow velocity.
- Retaining soil particles on site.

#### **APPLICATIONS**

This BMP may be used for temporary check dams in ditches of any dimension. This BMP may be used for perimeter protection. It may be used in combination with other barriers.

This BMP may be used below disturbed areas subject to sheet and rill erosion where drainage area is no greater than .25 acre per 100 lineal feet of barrier and the slope behind the barrier should be no steeper than 2 horizontal to 1 vertical. On relatively flat slopes the maximum disturbed slope distance should not exceed 100 feet. The allowable disturbed slope distance decreases as the slope gets steeper.

#### **LIMITATIONS**

This BMP should not be used:

- Where flow volume or velocity inhibit BMP function.
- As a filter.
- When maintenance activities could reduce actual or potential high flow salmonid refuge functions, this BMP will only be used if:



- Required or allowed by permit conditions.
- Required by other regulations.

### **CONSTRUCTION GUIDELINES**

- Install with the long flap upstream.
- Install to prevent water from going around or under BMP.
- BMP should be placed along contours.
- BMP must be anchored with adhesive on asphalt or other hard surfaces or staples or stakes on soil or soft surfaces.

### **BMP MAINTENANCE**

- During construction, inspect BMPs daily during the workweek. Schedule additional inspections during storm events. Make any required repairs.
- Sediment should be removed when deposits reach one-half the height of the BMP.

### **BMP REMOVAL**

- Evaluate site to determine BMP is no longer needed (the area has stabilized—potential of sediment laden water exiting the area has passed).
- Remove sediment buildup in front of BMP.
- Remove BMP (recycle and/or re-use if applicable).
- Use sweeper or hand broom to clean road surface.
- Depending upon BMP placement, re-vegetation of site may be necessary.



BMP: TRIANGULAR SILT DIKE (continued)

---



*A triangular silt dike detaining water and allowing soil particles to settle*



*A triangular silt dike in place with accumulated sediment being retained on site, prior to cleaning*





### TRIANGULAR SILT DIKE DETAIL

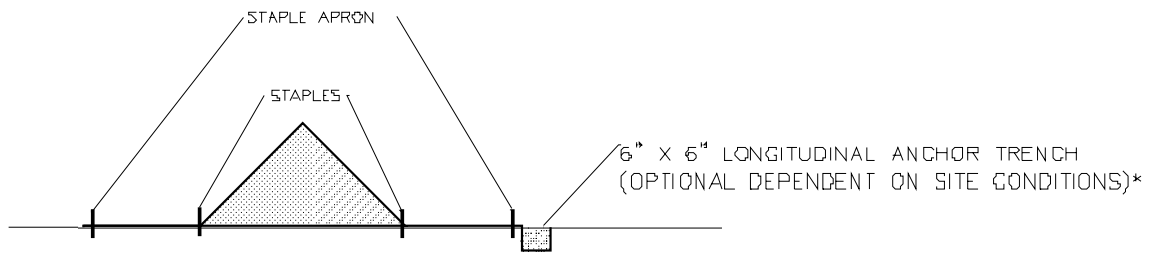
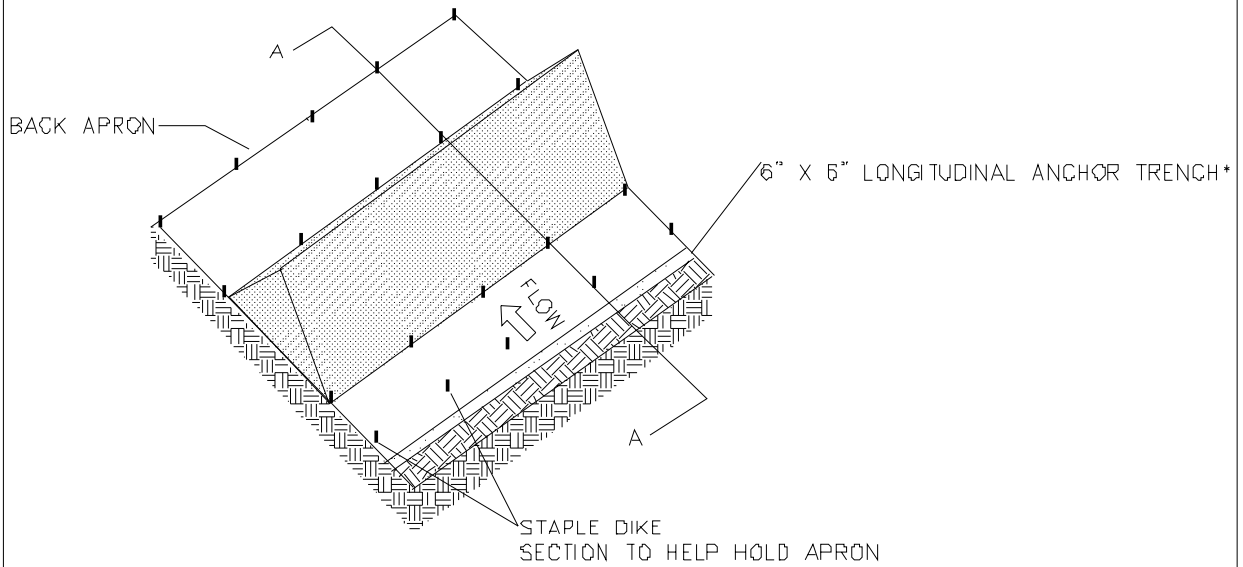

DETAIL A-A

\* TRENCH APRON DEPENDENT ON SITE CONDITIONS AND MANUFACTURER'S SUGGESTED USE.



## **BMP** **TURBIDITY CURTAIN**

---

### **DESCRIPTION**

**A** turbidity curtain is a pre-manufactured floating geotextile structure which minimizes turbidity transport from a disturbed area adjacent to or within a body of water. This device allows for settling of suspended solids and/or reducing water velocity.

### **PURPOSE**

The purpose of this BMP includes, but is not limited to:

- Minimizing the mixing of turbid water with the adjacent clean water.
- Containing soil particles during construction and/or repair activities.

### **APPLICATIONS**

This BMP may be used in water including open drainage systems, non-tidal and tidal watercourses where construction activities create turbidity.

### **LIMITATIONS**

This BMP should not be used:

- Across the entire flow of the watercourse or stream.
- To cross more than  $2/3$  of the main flow of any salmonids bearing water at the time of the year when any life history stage of salmonids are expected to be present.
- Where flow volume or water velocity inhibit BMP function.

### **CONSTRUCTION GUIDELINES**

- Turbidity curtains must be installed according to applicable permit requirements.
- Follow manufacturer recommendations and guidelines for installation and safety measures.
- Turbidity curtains are available in various heights. The units are preassembled in 50-foot lengths and are used by connecting the number of units required.
- Add a suitable weight or anchoring system to the bottom of the curtain.
- See drawings on following pages.



- The turbidity curtain can be deployed in standing and/or in flowing water (see limitations).

### **BMP MAINTENANCE**

- During construction, inspect BMPs daily during the workweek. Schedule additional inspections during storm events. Make any required repairs.
- Inspect daily.
- If repairs are required, follow directions in repair kit instructions.

### **BMP REMOVAL**

- Remove BMP (recycle and/or reuse if applicable).
- Follow manufacturer recommendations for removal.
- When curtain is removed it shall be in such a manner as to minimize turbidity. Remaining soil particles shall be sufficiently settled before removing the curtain.
- Water discharged from turbidity curtain shall meet permit requirements at the point of discharge.



*A river repair project in progress using a turbidity curtain to contain turbid water*



BMP: TURBIDITY CURTAIN (continued)

TURBIDITY CURTAIN TYPE III

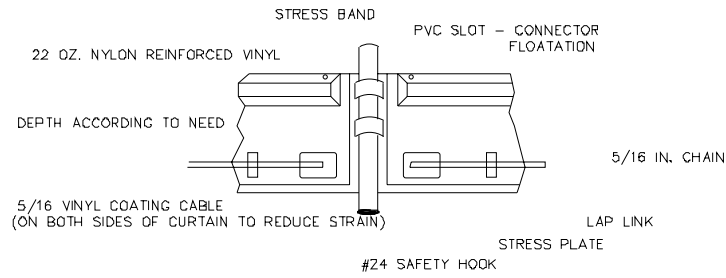

ORIENTATION WHEN INSTALLED  
(TIDAL SITUATION - TYPE III)

NOTE: ANCHORING WITH BUOYS, AS SHOWN, REMOVES ALL VERTICAL FORCES FROM THE CURTAIN. HENCE, THE CURTAIN WILL NOT SINK FROM WIND OR CURRENT LOADS.

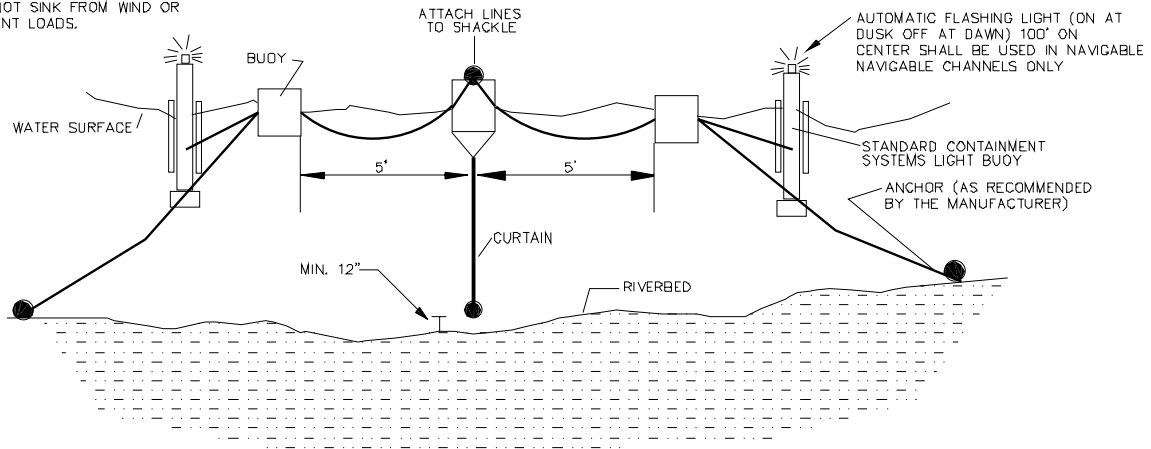



## TURBIDITY CURTAIN

TYPICAL LAYOUTS;  
STREAMS, PONDS, AND LAKES (PROTECTED AND NON-TIDAL)

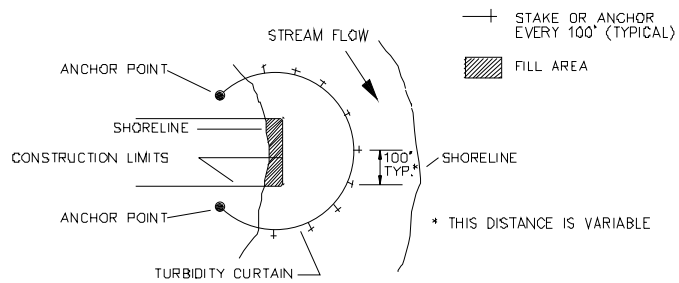

TIDAL WATERS AND/OR HEAVY WIND AND WAVE ACTION

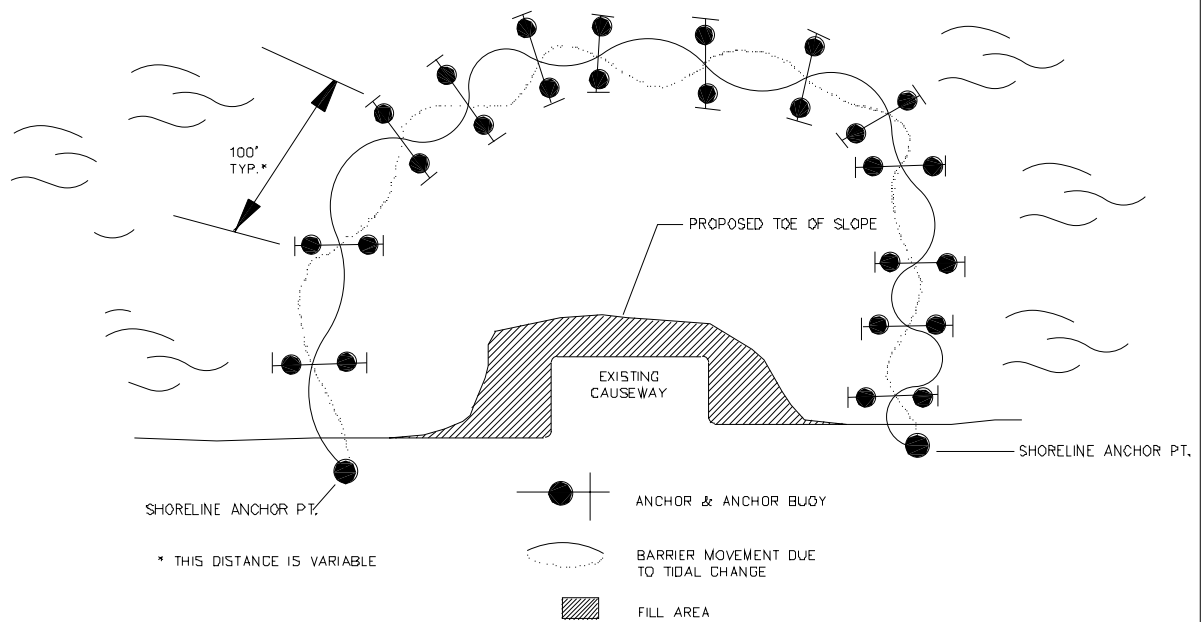



## **BMP VACTORING**

### **DESCRIPTION**

**V**actoring is the use of a truck mounted drainage system cleaning device. The cleaning device operates on the principle of large volume, high-speed air movement to lift water, soil particles/sediment, contaminants and debris. A large tube conveys the collected materials into a tank mounted on the truck. The cleaning device also includes a freshwater supply and high-pressure pump system to flush and clean pipes and structures. Collected material is transported in the truck to approved disposal sites.

### **PURPOSE**

The purpose of this BMP includes, but is not limited to:

- Cleaning drainage systems.
- Dewatering the work area.

### **APPLICATIONS**

This BMP may be used to clean and/or dewater enclosed drainage systems, open drainage systems, excavations and settling ponds. It may be used in conjunction with other BMPs.

### **LIMITATIONS**

This BMP should not be used:

- Where the flow exceeds the capacity of the cleaning device.
- To remove large debris.

### **CONSTRUCTION GUIDELINES**

- When used in a watercourse or stream, vactoring should be done according to applicable permit requirements.
- Reduce potential for sediment and debris from re-entering water.
- If entering a confined space use appropriate air testing and entry procedures.
- Prepare work sequence to address backup equipment or project phasing when tank is full.



---

## **BMP MAINTENANCE**

- Follow manufacturer's operation and service guidelines.

## **BMP REMOVAL**

- BMP removal is not applicable.



*Vactor truck removing sediment from catch basin*



## **BMP VEGETATIVE BUFFER**

---

### **DESCRIPTION**

**A** vegetative buffer is a strip of vegetation (grasses and small forbes) adjacent to shoulders, ditches, pavement, and/or gravel roads. This BMP reduces soil from becoming water borne and reduces water velocity/erosive forces.

### **PURPOSE**

The purpose of the BMP includes, but is not limited to:

- Providing bio-filtration.
- Reducing soil particles, snow sand and debris from entering ditches or the drainage system.
- Providing habitat and shade when planted along stream and/or watercourse banks.
- Providing habitat for prey base organisms such as macro-invertebrates.
- Allowing plants to grow over the ditch or channel.
- Providing shade as long as it does not become a public safety hazard.

### **APPLICATIONS**

This BMP may be used adjacent to ditches and/or sensitive areas, parallel to roadways, parking lots or at road crossings and must comply with back of slope BMPs along ditch lines. It may be used in combination with other BMPs.

### **LIMITATIONS**

This BMP should not be used:

- If it creates a potential public safety hazard according to federal, state, or city safety standards.
- If it prohibits infiltration or prevents sheet flows.

### **CONSTRUCTION GUIDELINES**

- To the greatest extent possible, preserve existing vegetation as a buffer.
- See other BMPs such as, handseeding, hydroseeding and/or live staking for construction guidelines.





### **BMP MAINTENANCE**

- Mow or trim the vegetative buffer in accordance with applicable standards.
- Re-vegetate as necessary.

### **BMP REMOVAL**

- BMP removal is not necessary.



*Using a ditchmaster  
to leave a vegetative  
buffer*



*Roadside ditch with a vegetative buffer*



## **BMP WASHED ROCK**

---

### **DESCRIPTION**

**W**ashed rock is sediment free non-angular gravel.

### **PURPOSE**

The purpose of this BMP includes, but is not limited to:

- Minimizing siltation in ditches and/or stormwater facilities.
- Reducing velocity and erosive forces.
- Filtering soil particles from water.
- Stabilizing disturbed areas.

### **APPLICATIONS**

This BMP may be used wherever gravel will be placed in ditches and/or stormwater facilities which are watercourses or streams. It may be used in combination with other BMPs.

### **LIMITATIONS**

This BMP should not be used:

- In locations where design and/or permit conditions prescribe other streambed material.
- On steep slopes.
- On road shoulders.

### **CONSTRUCTION GUIDELINES**

- Wash rock off-site (at a location where washed water can not enter watercourses, streams or wetlands) until water runs clear.
- Haul material in clean truck bed.
- Dump cleaned rock onto tarped area on-site.
- Place cover and berms around clean rock that will not be used immediately.

### **BMP MAINTENANCE**

- Inspect stockpiles of cleaned rock periodically. If rock becomes contaminated rewash rock prior to use.

### **BMP REMOVAL**

- BMP removal is not applicable.